



# Dell™ PowerEdge™ 2650 Systems Installation and Troubleshooting Guide

[Introduction](#)  
[Indicators, Messages, and Codes](#)  
[Finding Software Solutions](#)  
[Running System Diagnostics](#)  
[Troubleshooting Your System](#)  
[Installing System Options](#)  
[Installing Drives](#)  
[Getting Help](#)  
[Jumpers and Connectors](#)  
[Abbreviations and Acronyms](#)

---

## Notes, Notices, and Cautions

-  **NOTE:** A NOTE indicates important information that helps you make better use of your computer.
  -  **NOTICE:** A NOTICE indicates either potential damage to hardware or loss of data and tells you how to avoid the problem.
  -  **CAUTION:** A CAUTION indicates a potential for property damage, personal injury, or death.
- 

Information in this document is subject to change without notice.  
© 2001 Dell Computer Corporation. All rights reserved.

Reproduction in any manner whatsoever without the written permission of Dell Computer Corporation is strictly forbidden.

Trademarks used in this text: *Dell*, the *DELL* logo, *PowerEdge*, *Dell OpenManage*, *Dimension*, *Inspiron*, *Dell Precision*, *OptiPlex*, *Latitude*, and *DellNet* are trademarks of Dell Computer Corporation; *Intel* is a registered trademark of Intel Corporation; *Microsoft*, *MS-DOS*, and *Windows* are registered trademarks of Microsoft Corporation.

Other trademarks and trade names may be used in this document to refer to either the entities claiming the marks and names or their products. Dell Computer Corporation disclaims any proprietary interest in trademarks and trade names other than its own.

---

Initial release: 19 Dec 01

[Back to Contents Page](#)

## Jumpers and Connectors

### Dell™ PowerEdge™ 2650 Systems Installation and Troubleshooting Guide

- [Jumpers—A General Explanation](#)
- [System Board Jumpers](#)
- [System Board Connectors](#)
- [Expansion-Card Riser-Board Components and PCI Buses](#)
- [SCSI Backplane Board Connectors](#)
- [Disabling a Forgotten Password](#)

This section provides specific information about the system jumpers. It also provides some basic information on jumpers and switches and describes the connectors on the various boards in the system.

---

## Jumpers—A General Explanation

Jumpers provide a convenient and reversible way of reconfiguring the circuitry on a printed circuit board. When reconfiguring the system, you may need to change jumper settings on circuit boards or drives.

### Jumpers

Jumpers are small blocks on a circuit board with two or more pins emerging from them. Plastic plugs containing a wire fit down over the pins. The wire connects the pins and creates a circuit. To change a jumper setting, pull the plug off its pin(s) and carefully fit it down onto the pin(s) indicated. [Figure A-1](#) shows an example of a jumper.

Figure A-1. Example Jumpers

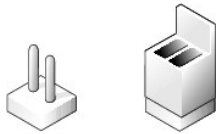

**⚠ CAUTION:** Ensure that the system is turned off before you change a jumper setting. Otherwise, damage to the system or unpredictable results may occur.

A jumper is referred to as open or unjumped when the plug is pushed down over only one pin or if there is no plug at all. When the plug is pushed down over two pins, the jumper is referred to as jumped. The jumper setting is often shown in text as two numbers, such as 1-2. The number 1 is printed on the circuit board so that you can identify each pin number based on the location of pin 1.

[Figure A-2](#) shows the location and default settings of the system jumper blocks. See [Table A-1](#) for the designations, default settings, and functions of the system's jumpers.

---



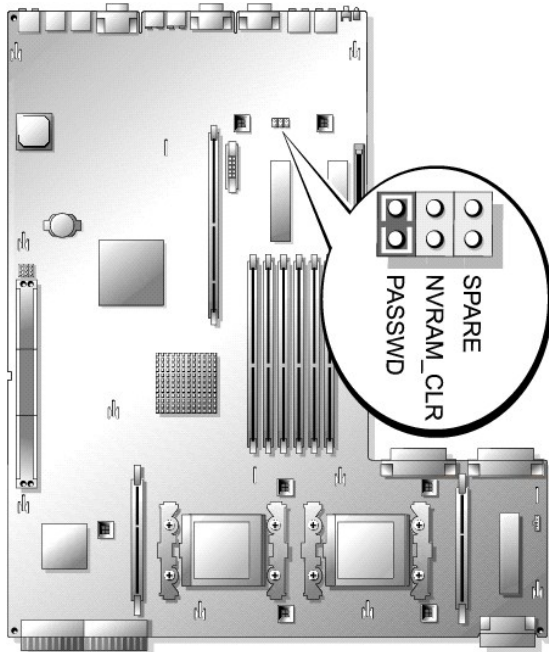

## System Board Jumpers

[Figure A-2](#) shows the location of the configuration jumpers on the system board. [Table A-1](#) lists the jumpers settings.

Figure A-2. System Board Jumpers



**Table A-1. System Board Jumper Settings**

Jumper	Setting	Description
PASSWD	 (default)	The password feature is enabled.
		The password feature is disabled.
NVRAM_CLR	 (default)	The configuration settings are retained at system boot.
		The configuration settings are cleared at next system boot. (If the configuration settings become corrupted to the point where the system will not boot, install the jumper and boot the system. Remove the jumper before restoring the configuration information.)
SPARE	—	To store a spare, unused jumper.

**NOTE:** For the full name of an abbreviation or acronym used in this table, see "[Abbreviations and Acronyms](#)."

## System Board Connectors

See [Figure A-3](#) and [Table A-2](#) for the location and description of system board connectors.

**Figure A-3. System Board Connectors**

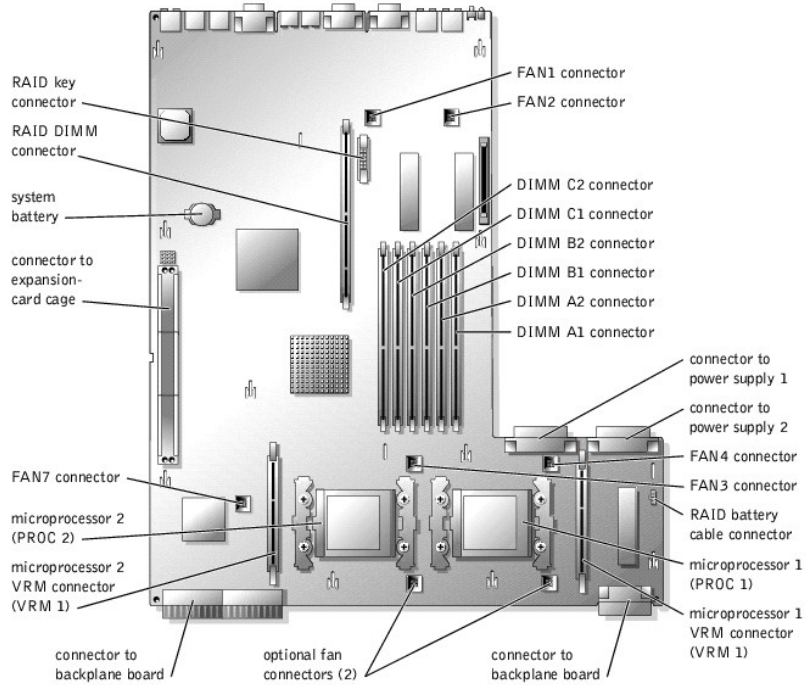

**Table A-2. System Board Connectors**

Connector	Description
BATTERY	System battery
DIMM $X_n$	Memory modules (6), where $X$ is the bank and $n$ is the slot in the bank
FAN $n$	Cooling fans: <ul style="list-style-type: none"> <li>  1, 2 — system fans</li> <li>  3, 4 — microprocessors (2)</li> <li>  5, 6 — optional</li> <li>  7 — expansion cards</li> </ul>
PROC $n$	Microprocessors (2)
RAID_BAT	Battery cable for optional integrated RAID controller
RAID_DIMM	Memory module for optional integrated RAID controller
RAID_KEY	Hardware key for optional integrated RAID controller
VRM $n$	Microprocessor VRMs (2)
<b>NOTE:</b> For the full name of an abbreviation or acronym used in this table, see " <a href="#">Abbreviations and Acronyms.</a> "	

## Expansion-Card Riser-Board Components and PCI Buses

[Figure A-4](#) shows the components on the expansion-card riser board, including the expansion-card slots and buses. [Table 6-1](#) lists the PCI bus and operating speed for each expansion-card slot.

**Figure A-4. Expansion-Card Riser-Board Components**

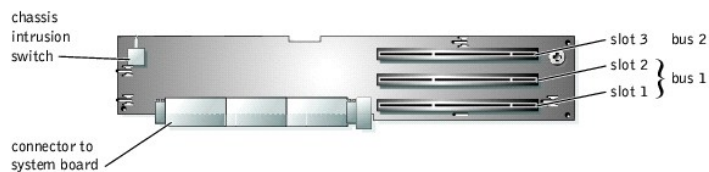

---

## SCSI Backplane Board Connectors

Figure A-5 shows the location of the connectors on the SCSI backplane board.

Figure A-5. SCSI Backplane Board Components

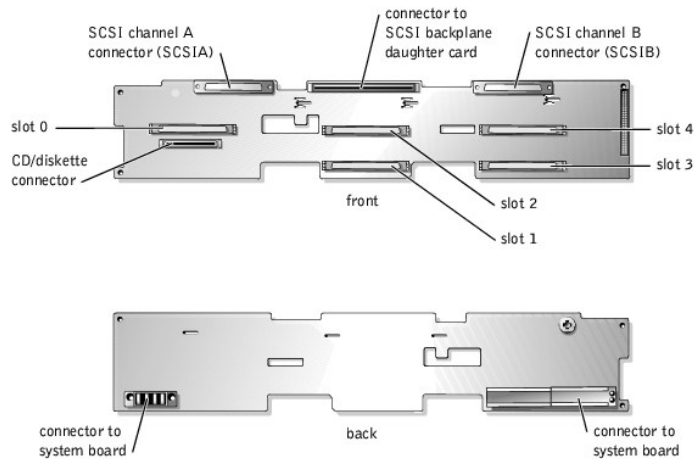

---

## Disabling a Forgotten Password

The system's software security features include a system password and a setup password, which are discussed in detail in "Using the System Setup Program" in the *User's Guide*. The password jumper enables these password features or disables them and clears any password(s) currently in use.

**NOTICE:** See "Protecting Against Electrostatic Discharge" in the safety instructions in your *System Information* document.

1. Turn off the system, including any attached peripherals, and disconnect the system from the electrical outlet.
2. Remove the cover (see "[Removing the Cover](#)" in "Troubleshooting Your System").
3. Remove the jumper plug from the password jumper.

See [Figure A-2](#) to locate the password jumper (labeled "PASSWD") on the system board.

4. Replace the cover (see "[Replacing the Cover](#)" in "Troubleshooting Your System").
5. Reconnect your system and peripherals to their electrical outlets, and turn on the system.

The existing passwords are not disabled (erased) until the system boots with the password jumper plug removed. However, before you assign a new system and/or setup password, you must install the jumper plug.

**NOTE:** If you assign a new system and/or setup password with the jumper plug still removed, the system disables the new password(s) the next time it boots.

6. Turn off the system, including any attached peripherals, and disconnect the system from the electrical outlet.
7. Remove the cover (see "[Removing the Cover](#)" in "Troubleshooting Your System").
8. Install the jumper plug on the password jumper.
9. Replace the cover (see "[Replacing the Cover](#)" in "Troubleshooting Your System").
10. Reconnect your system and peripherals to their electrical outlets, and turn on the system.
11. Assign a new system and/or setup password.

To assign a new passwords using the System Setup program, see "Assigning a System Password" in the *User's Guide*.



[Back to Contents Page](#)

## Abbreviations and Acronyms

Dell™ PowerEdge™ 2650 Systems Installation and Troubleshooting Guide

### A

ampere(s)

### AC

alternating current

### ADC

analog-to-digital converter

### ANSI

American National Standards Institute

### APIC

Advanced Peripheral Interrupt Controller

### ASIC

application-specific integrated circuit

### BIOS

basic input/output system

### BMC

baseboard management controller

### bpi

bits per inch

### bps

bits per second

### BTU

British thermal unit

### C

Celsius

### CD

compact disc

### CGA

color graphics adapter

### cm

centimeter(s)

### CMOS

complementary metal oxide semiconductor

### COM

communications

### cpi

characters per inch

### cpl

characters per line

**CPU**

central processing unit

**DAC**

digital-to-analog converter

**DAT**

digital audio tape

**dB**

decibel(s)

**dBA**

adjusted decibel(s)

**DC**

direct current

**DDR**

double-data rate

**DIMM**

dual in-line memory module

**DIN**

Deutsche Industrie Norm

**DIP**

dual in-line package

**DMA**

direct memory access

**DOC**

Department of Communications (in Canada)

**dpi**

dots per inch

**DRAC III**

remote access card

**DRAM**

dynamic random-access memory

**DS/DD**

double-sided double-density

**DS/HD**

double-sided high-density

**ECC**

error checking and correction

**EDO**

extended-data out

**EGA**



enhanced graphics adapter

**EIDE**

enhanced integrated drive electronics

**EMI**

electromagnetic interference

**EMM**

expanded memory manager

**EMS**

Expanded Memory Specification

**EPP**

Enhanced Parallel Port

**EPROM**

erasable programmable read-only memory

**ERA**

embedded remote access

**ESD**

electrostatic discharge

**ESDI**

enhanced small-device interface

**ESM**

embedded server management

**F**

Fahrenheit

**FAT**

file allocation table

**FCC**

Federal Communications Commission

**ft**

feet

**g**

gram(s)

**G**

gravities

**GB**

gigabyte(s)

**GUI**

graphical user interface

**Hz**

hertz

**I/O**

input/output

**ID**

identification

**IDE**

integrated drive electronics

**IRQ**

interrupt request

**K**

kilo- (1024)

**KB**

kilobyte(s)

**KB/sec**

kilobyte(s) per second

**Kb**

kilobit(s)

**Kbps**

kilobit(s) per second

**kg**

kilogram(s)

**kHz**

kilohertz

**LAN**

local area network

**lb**

pound(s)

**LCD**

liquid crystal display

**LED**

light-emitting diode

**LIF**

low insertion force

**LN**

load number

**lpi**

lines per inch

**LVD**

low voltage differential

**m**

meter(s)

**mA**

milliampere(s)

**mAh**

milliampere-hour(s)

**MB**

megabyte(s)

**Mb**

megabit(s)

**Mbps**

megabit(s) per second

**MBR**

master boot record

**MDA**

monochrome display adapter

**MGA**

monochrome graphics adapter

**MHz**

megahertz

**mm**

millimeter(s)

**ms**

millisecond(s)

**MTBF**

mean time between failures

**mV**

millivolt(s)

**NIC**

network interface controller

**NiCad**

nickel cadmium

**NiMH**

nickel-metal hydride

**NMI**

nonmaskable interrupt

**ns**

nanosecond(s)

**NTFS**

NT File System

**NVRAM**

nonvolatile random-access memory

**OTP**

one-time programmable

**PAL**

programmable array logic

**PCI**

Peripheral Component Interconnect

**PCMCIA**

Personal Computer Memory Card International Association

**PDB**

power distribution board

**PDU**

power distribution unit

**PGA**

pin grid array

**PIC**

personal identification code

**POST**

power-on self-test

**ppm**

pages per minute

**PQFP**

plastic quad flat pack

**PSDB**

power-supply distribution board

**PS/2**

Personal System/2

**PXE**

preboot execution environment

**RAID**

redundant arrays of independent disks

**RAC**

Remote access controller

**RAM**

random-access memory

**RCU**

Resource Configuration Utility

**REN**

ringer equivalence number

**RFI**

radio frequency interference

**RGB**

red/green/blue

**ROM**

read-only memory

**rpm**

revolutions per minute

**RTC**

real-time clock

**SBE**

single bit ECC

**SCSI**

small computer system interface

**sec**

second(s)

**SEC**

single-edge contact

**SEL**

system event log

**SDRAM**

synchronous dynamic random-access memory

**SIMM**

single in-line memory module

**SMB**

server management bus

**SMI**

system management interrupt

**SNMP**

Simple Network Management Protocol

**SRAM**

static random-access memory

**SVGA**

super video graphics array

**TFT**

thin film transistor

**tpi**

tracks per inch

**UMB**

upper memory block

**UPS**

uninterruptible power supply

**USB**

universal serial bus

**V**

volt(s)

**VAC**

volt(s) alternating current

**VDC**

volt(s) direct current

**VGA**

video graphics array

**VLSI**

very-large-scale integration

**VRAM**

video random-access memory

**VRM**

voltage regulator module

**W**

watt(s)

**WH**

watt-hour(s)

**XMM**

extended memory manager

**XMS**

eXtended Memory Specification

**ZIF**

zero insertion force

---

[Back to Contents Page](#)

[Back to Contents Page](#)

## Introduction

### Dell™ PowerEdge™ 2650 Systems Installation and Troubleshooting Guide

- [Other Documents You May Need](#)
- [Obtaining Technical Assistance](#)

Your system is a high-speed server that offers significant service and upgrade features. The system includes the following service features to make troubleshooting and repair easy and effective:

- 1 Embedded remote access hardware, which monitors temperatures and voltages throughout the system and notifies you if the system overheats, if a system cooling fan malfunctions, or if a power supply fails
- 1 Hot-pluggable cooling fans
- 1 Redundant, hot-pluggable power supplies
- 1 System diagnostics, which checks for hardware problems (if the system can boot)

System upgrade options are offered, including:

- 1 An additional microprocessor
- 1 Additional system memory
- 1 A variety of PCI and PCI-X expansion-card options (including RAID controller cards)
- 1 An integrated RAID controller that can be activated with an additional memory module, key, and battery

---

## Other Documents You May Need

Besides this *Installation and Troubleshooting Guide*, the following documentation is included with your system:

- 1 The *Setting Up Your System* sheet provides general instructions for setting up your system.
- 1 The *System Information* document provides important safety and regulatory information. Warranty information might be included within this document or as a separate document.
- 1 The *Rack Installation Guide* describes how to unpack, set up, and install your system in a rack.
- 1 The *User's Guide* describes system features and technical specifications, video and SCSI device drivers, the system setup program, and software support utilities.
- 1 The system management software documentation describes the features, requirements, installation, and basic operation of the systems management software. See the software's online help for information about the alert messages issued by the software.
- 1 Documentation included with any options you purchased separately from the system, which includes information that you need to configure and install these options in your system.

You may also have the following documents.

- 1 Operating system documentation if you ordered an operating system with your system. This documentation describes how to install (if necessary), configure, and use the operating system software.
- 1 Documentation updates are sometimes included with the system to describe changes to the system or software.
  - 📄 **NOTE:** Always read these updates before consulting any other documentation because the updates often contain information that supersedes the information in the other documents.
- 1 Optional solutions software documentation for web hosting, caching, or load balancing information.
- 1 Technical information files—sometimes called "readme" files—may be installed on the hard drive to provide last-minute updates about technical changes to the system or advanced technical reference material intended for experienced users or technicians.

---

## Obtaining Technical Assistance

If at any time you do not understand a procedure described in this guide or if your system does not perform as expected, a number of tools are provided to help you. For more information on these help tools, see "[Getting Help](#)."

---

[Back to Contents Page](#)

[Back to Contents Page](#)

## Indicators, Messages, and Codes

Dell™ PowerEdge™ 2650 Systems Installation and Troubleshooting Guide

- [System-Status Indicators](#)
- [System Identification Indicators](#)
- [Front-Panel Indicators and Features](#)
- [Back-Panel Indicators and Features](#)
- [Power Indicator Codes](#)
- [SCSI Hard-Drive Indicator Codes](#)
- [NIC Indicator Codes](#)
- [Cooling Fan Indicator Codes](#)
- [LCD Status Messages](#)
- [System Messages](#)
- [System Beep Codes](#)
- [Warning Messages](#)
- [Diagnostics Messages](#)
- [Alert Messages](#)

Applications, operating systems, and the system itself are capable of identifying problems and alerting you to them. When a problem occurs, a message may appear on the monitor or front-panel status LCD, or a beep code may sound.

A variety of messages and codes can indicate when the system is not functioning properly:

- 1 System-status indicators
- 1 System identification identifiers
- 1 Front-panel indicators and features
- 1 Back-panel indicators and features
- 1 Power indicator codes
- 1 SCSI hard-drive indicator codes
- 1 NIC indicator codes
- 1 Cooling fan indicator codes
- 1 LCD status messages
- 1 System messages
- 1 System beep codes
- 1 Warning messages
- 1 Diagnostics messages
- 1 Alert messages

The system indicators and features are illustrated in [Figure 2-1](#) through [Figure 2-6](#). This section also describes each type of message, and lists the possible causes and actions you can take to resolve any problems indicated by a message. To determine what type of message you have received, read the following subsections.

---

### System-Status Indicators

The system's bezel has an indicator that can represent system status when the bezel is installed (see [Figure 2-1](#)). The indicator signifies when the system is operating properly or when the system needs attention. The back-panel indicator functions the same as the bezel indicator. The back-panel indicator connector allows an indicator to be attached that will also function the same as the bezel indicator (see [Figure 2-3](#)).

A caution code signifies a problem with microprocessors, power supply, system or power-supply fans, system temperature, hard drives, system memory, expansion cards, or integrated SCSI controller.

[Table 2-1](#) lists the system's status indicator codes.

**Figure 2-1. System-Status Indicators**



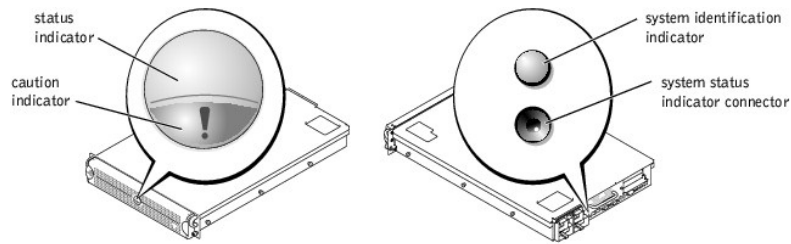

Table 2-1. System-Status Indicator Codes

Bezel Indicators		Back-Panel Indicators	Indicator Code
Status	Caution		
Off	Off	Off	No power is available to the system, or the system is not powered on.
On	Off	Blue	The system is operating normally.
Off	Blinking	Amber blinking	The system has detected an error and requires attention.
Blinking	Off	Blue blinking	The system is identifying itself (see " <a href="#">System Identification Indicators</a> ").

## System Identification Indicators

The identification buttons on the front and back panels can be used to identify a particular system within a rack. See [Figure 2-2](#) to locate the front-panel system identification button. See [Figure 2-3](#) to locate the back-panel system identification button and indicator.

When either of the identification buttons is pushed, the identification indicator on the back blinks until one of the buttons is pushed again. If the bezel is installed, the system status indicator will also blink. If an indicator is connected to the back-panel system status indicator connector, that indicator will also blink.

Systems management software can also be used to cause the status and identification indicators to blink to identify a particular system. For more information, see the systems management software documentation.

## Front-Panel Indicators and Features

Additional indicators are located behind the bezel. The front-panel status LCD provides information using an alphanumeric character display (see "[LCD Status Messages](#)"). See [Figure 2-2](#) for the front-panel indicators and features.

[Figure 2-2](#) shows the front-panel features of the system. [Table 2-2](#) describes the front-panel features.

Figure 2-2. Front-Panel Features

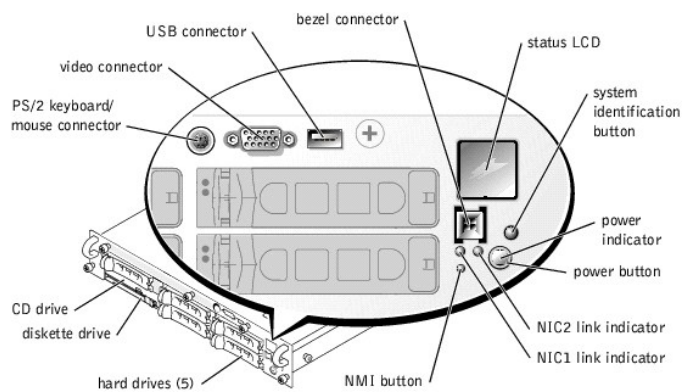

Table 2-2. Front-Panel Features

Component	Description
Power button	Turns system power off and on.

	<ol style="list-style-type: none"> <li>If you turn off the system using the power button and the system is running an ACPI-compliant operating system (such as Microsoft® Windows® 2000), the system can perform an orderly shutdown before power is turned off.</li> <li>If the system is not running an ACPI-compliant operating system, power is turned off immediately after the power button is pressed.</li> </ol> <p>The button is enabled in the System Setup program. When disabled, the button can only turn system power on. For more information, see the <i>User's Guide</i> and the operating system's documentation.</p>
Power indicator	Provides information on power status (see " <a href="#">Power Indicator Codes</a> ").
CD and diskette drive indicators	Indicates read or write access to the respective drive.
hard-drive indicators	Provide information on the status of the respective hard drive (see " <a href="#">SCSI Hard-Drive Indicator Codes</a> ").
NIC indicators	Indicate whether the NIC has a valid link to the network (see " <a href="#">NIC Indicator Codes</a> ").
Status LCD	Can signify when the system is operating correctly or when the system needs attention (see " <a href="#">LCD Status Messages</a> ").
System identification button	Can be used to identify a particular system (see " <a href="#">System Identification Indicators</a> ").
NMI button	<p>Can be used to troubleshoot software and device driver errors when using certain operating systems. This button is often referred to as a "force dump switch" and can be pressed using the end of a paper clip. When the option is enabled in the System Setup program and the button is pressed, an NMI alerts the system.</p> <p>Use this button only if directed to do so by qualified support personnel or by the operating system's documentation. For more information, see the <i>User's Guide</i> and the operating system's documentation.</p>

## Back-Panel Indicators and Features

[Figure 2-3](#) shows the back-panel features of the system. [Table 2-3](#) describes the back-panel features.

**Figure 2-3. Back-Panel Features**

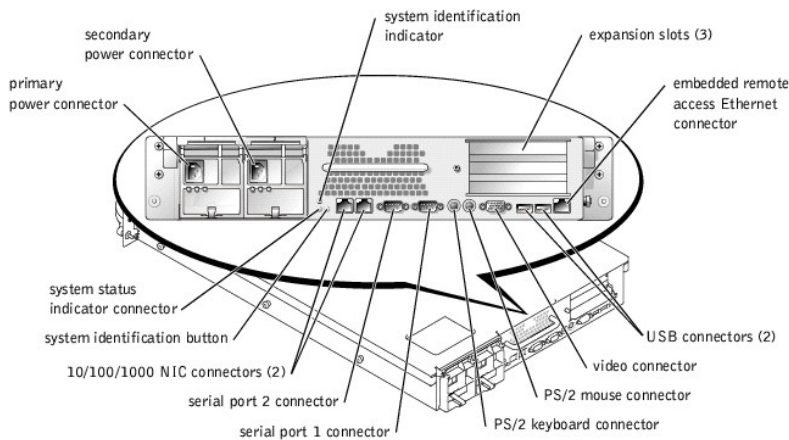

**Table 2-3. Back-Panel Features**

Component	Description
Power supply indicators	Provides information on power status (see " <a href="#">Power Indicator Codes</a> ").
NIC indicators	Provides information on NIC status (see " <a href="#">NIC Indicator Codes</a> ").
System status indicator connector	Connects to an indicator that can signify when the system is operating correctly or when the system needs attention (see " <a href="#">System-Status Indicators</a> ").
System identification indicator	Signifies when the system is operating correctly or when the system needs attention, and can identify a particular system (see " <a href="#">System Identification Indicators</a> ").
System identification button	Can be used to identify a particular system (see " <a href="#">System Identification Indicators</a> ").

## Power Indicator Codes

The system has indicators on the front panel and the power supplies that signify system power status.

## Power-Button Indicator Codes

The power button controls the power input to the system's power supplies. The power button indicator can provide information on power status (see [Figure 2-2](#)).

[Table 2-4](#) lists the power button indicator codes.

**Table 2-4. Power-Button Indicator Codes**

Indicator	Indicator Code
On	Indicates that power is supplied to the system, and the system is operational.
Off	Indicates that no power is supplied to the system.
Blinking	Indicates that power is supplied to the system, but the system is in a standby state. For more information on standby states, see your operating system documentation.

## Power-Supply Indicator Codes

Each hot-pluggable power supply has indicators that can provide information on power status, fault, and the presence of power (see [Figure 2-4](#)). [Table 2-5](#) lists the power-supply indicator codes.

**Figure 2-4. Power-Supply Indicators**

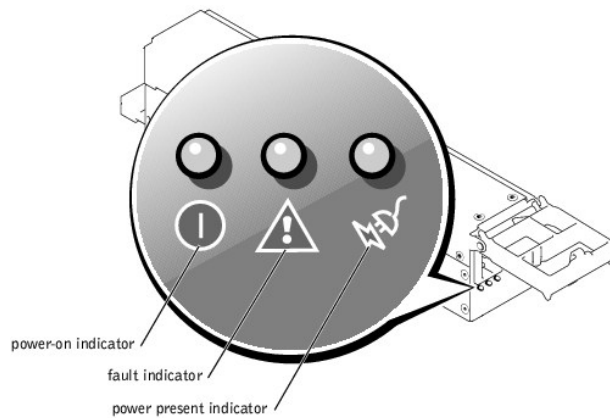

**Table 2-5. Power-Supply Indicator Codes**

Indicator	Indicator Code
Power-on	Green indicates that the power supply is operational.
Fault	Red indicates a problem with the power supply (fan failure, voltage error, etc.).
Power present	Green indicates that power is present at the power supply and that the system is connected to a power source.

## SCSI Hard-Drive Indicator Codes

Each SCSI hard-drive carrier has two indicators: a busy indicator and a status indicator (see [Figure 2-5](#)). The indicators provide information on the status of the respective hard drive. [Table 2-6](#) lists the drive indicator codes.

**Figure 2-5. SCSI Hard-Drive Indicators**

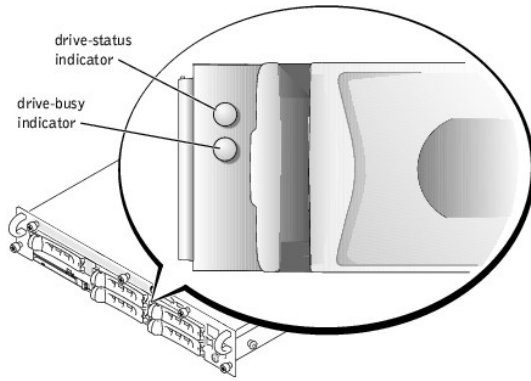

Table 2-6 lists the drive indicator codes. Different codes display as drive events occur in the system. For example, in the event of a hard-drive failure, the "drive fail" code appears. After the drive is selected for removal, the "preparing for removal" code appears. After the replacement drive is installed, the "preparing for operation, drive online" code appears.

Table 2-6. SCSI Hard-Drive Indicator Codes

Drive Status Indicator	Indicator Code
Drive bay empty, ready for insertion or removal	Off
Drive being prepared for operation, drive online	Steady green
Drive being identified	Blinks green four times per second
Drive being prepared for removal	Blinks green twice per second at equal intervals
Drive rebuilding	Blinks green twice per second at unequal intervals
Drive failed	Blinks amber four times per second
Predicted failure for the drive	Blinks green, then amber, and then off, repeating this sequence every two seconds

**NOTE:** The drive busy indicator signifies whether the hard drive is active on the SCSI bus. This indicator is controlled by the hard drive.

## NIC Indicator Codes

Each NIC on the back panel has an indicator that provides information on network activity and link status (see Figure 2-6). Table 2-7 lists the NIC indicator codes on the back panel.

The front panel has a link indicator for each NIC (see Figure 2-2). Each indicator signifies whether the corresponding NIC is connected to a valid link partner on the network.

Figure 2-6. NIC Indicators

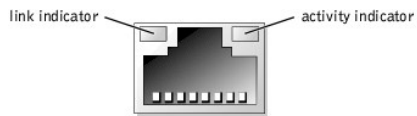

Table 2-7. NIC Indicator Codes

Indicator	Indicator Code
Link and activity indicators are off	The NIC is not connected to the network.
Link indicator is green	The NIC is connected to a valid link partner on the network.
Activity indicator is amber blinking	Network data is being sent or received.

## Cooling Fan Indicator Codes

Each individual fan has a status indicator on the system board adjacent to the respective fan's connector (see Figure 2-7). To locate the fan connectors on the system board, see Figure A-3. Table 2-8 lists the fan indicator codes.

Figure 2-7. Cooling Fan Indicators

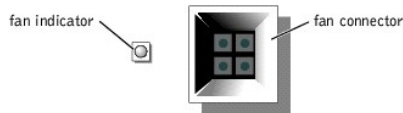

**Table 2-8. Cooling Fan Indicator Codes**

Indicator	Indicator Code
Off	The fan is not installed.
Green	The fan is operating normally.
Amber blinking	The fan is malfunctioning.

## LCD Status Messages

The system's bezel indicator can signify when the system is operating correctly or when the system needs attention (see [Figure 2-1](#)). When the bezel indicator signifies an error condition, remove the bezel to see further information provided by the status LCD.

The LCD can display two lines of alphanumeric characters. The display codes are presented in two color combinations:

- 1 White characters on a blue background — Information only; no action is required.
- 1 Amber characters on a black background — The system needs attention.

[Table 2-9](#) lists the LCD status messages that can occur and the probable cause for each message. The LCD messages refer to events recorded in the SEL. For information on the SEL and configuring system management settings, see the systems management software documentation.

 **NOTE:** Before you perform any procedures described in [Table 2-9](#), see "[Before You Begin](#)" in "Troubleshooting Your System."

**Table 2-9. LCD Status Messages**

Line 1 Message	Line 2 Message	Causes	Corrective Actions
<i>SYSTEM ID</i>	SYSTEM NAME	<p><i>SYSTEM ID</i> is a unique name, five characters or less, defined by the user.</p> <p><i>SYSTEM NAME</i> is a unique name, 16 characters or less, defined by the user.</p> <p>The system ID and name display under the following conditions:</p> <ul style="list-style-type: none"> <li>1 The system is powered on.</li> <li>1 The power is off and active POST errors are displayed.</li> </ul>	<p>This message is for information only.</p> <p>You can change the system ID and name in the System Setup program. See your system's <i>User's Guide</i> for instructions.</p>
E0000	OVRFLW CHECK LOG	<p>LCD overflow message.</p> <p>A maximum of three error messages can display sequentially on the LCD. The fourth message displays as the standard overflow message.</p>	Check the SEL for details on the events.
E0119	TEMP AMBIENT	Ambient system temperature is out of acceptable range.	See " <a href="#">Troubleshooting System Cooling</a> " in "Troubleshooting Your System."
E0119	TEMP BP	Backplane board is out of acceptable temperature range.	
E0119	TEMP CPU <i>n</i>	Specified microprocessor is out of acceptable temperature range.	
E0119	TEMP SYSTEM	System board is out of acceptable temperature range.	See " <a href="#">Troubleshooting System Cooling</a> " in "Troubleshooting Your System."
E0212	VOLT 3.3	System power supply is out of acceptable voltage range; faulty or improperly installed power supply.	See " <a href="#">Troubleshooting Power Supplies</a> " in "Troubleshooting Your System."
E0212	VOLT 5		
E0212	VOLT 12		
E0212	VOLT BATT	Faulty battery; faulty system board.	See " <a href="#">Troubleshooting the System Battery</a> " in "Troubleshooting Your System."
E0212	VOLT BP 12	Backplane board is out of acceptable voltage range.	Ensure that the power cables are securely connected to the backplane board (see " <a href="#">Installing Drives</a> "). If the problem persists, see " <a href="#">Troubleshooting Power Supplies</a> " in "Troubleshooting Your System."
E0212	VOLT BP 3.3		
E0212	VOLT BP 5		

E0212	VOLT CPU VRM	Microprocessor VRM voltage is out of acceptable range; faulty or improperly installed microprocessor VRM; faulty system board.	Ensure that supported VRMs of the same type are properly installed. If the problem persists, replace the VRMs (see <a href="#">Figure 6-9</a> ). If the problem persists, see <a href="#">Getting Help</a> .
E0212	VOLT NIC 1.8V	Integrated NIC voltage is out of acceptable range; faulty or improperly installed power supply; faulty system board.	See <a href="#">Troubleshooting Power Supplies</a> in "Troubleshooting Your System."
E0212	VOLT NIC 2.5V		
E0212	VOLT PLANAR REG		
E0276	CPU VRM <i>n</i>	Specified microprocessor VRM is faulty, unsupported, improperly installed, or missing.	Ensure that supported VRMs of the same type are properly installed. If the problem persists, replace the VRM (see <a href="#">Figure 6-9</a> in "Installing System Options").
E0276	MISMATCH VRM <i>n</i>		
E0280	MISSING VRM <i>n</i>		
E0319	PCI OVER CURRENT	Faulty or improperly installed expansion card.	See <a href="#">Troubleshooting Expansion Cards</a> in "Troubleshooting Your System."
E0412	RPM FAN <i>n</i>	Specified cooling fan is faulty, improperly installed, or missing.	See <a href="#">Troubleshooting a Cooling Fan</a> in "Troubleshooting Your System."
E0780	MISSING CPU 1	<b>Microprocessor is not installed in socket 1.</b>	Install a microprocessor in socket 1 (see <a href="#">Adding or Replacing a Microprocessor</a> in "Installing System Options"). To identify microprocessor socket 1, see <a href="#">Figure A-3</a> .
E07F0	CPU IERR	Faulty or improperly installed microprocessor.	See <a href="#">Troubleshooting a Microprocessor</a> in "Troubleshooting Your System."
E07F1	TEMP CPU <i>n</i> HOT	Specified microprocessor is out of acceptable temperature range and has halted operation.	See <a href="#">Troubleshooting System Cooling</a> in "Troubleshooting Your System." If the problem persists, ensure that the microprocessor heat sinks are properly installed (see <a href="#">Adding or Replacing a Microprocessor</a> in "Installing System Options").
E07F4	POST CACHE	Faulty or improperly installed microprocessor.	See <a href="#">Troubleshooting a Microprocessor</a> in "Troubleshooting Your System."
E07F4	POST CPU REG		
E07F4	POST CPU SMI		
E07FA	TEMP CPU <i>n</i> THERM	Specified microprocessor is out of acceptable temperature range and is operating at a reduced speed, or frequency.	See <a href="#">Troubleshooting System Cooling</a> in "Troubleshooting Your System." If the problem persists, ensure that the microprocessor heat sinks are properly installed (see <a href="#">Adding or Replacing a Microprocessor</a> in "Installing System Options").
E0876	POWER PS <i>n</i>	No power available from the specified power supply; specified power supply is improperly installed or faulty.	See <a href="#">Troubleshooting Power Supplies</a> in "Troubleshooting Your System."
E0880	INSUFFICIENT PS	Insufficient power is being supplied to the system; power supplies are improperly installed, faulty, or missing.	See <a href="#">Troubleshooting Power Supplies</a> in "Troubleshooting Your System."
E0CB2	MEM SPARE ROW	Correctable errors threshold was met in a memory bank; errors were remapped to the spare row.	See <a href="#">Troubleshooting System Memory</a> in "Troubleshooting Your System."
E0CF1	MBE DIMM Bank <i>n</i>	Memory modules installed in the specified bank are not the same type and size; faulty memory module(s).	Ensure that all banks contain memory modules of the same type and size and that they are properly installed. If the problem persists, see <a href="#">Troubleshooting System Memory</a> in "Troubleshooting Your System."
E0CF1	POST MEM 64K	Parity failure in the first 64 KB of main memory.	See <a href="#">Troubleshooting System Memory</a> in "Troubleshooting Your System."
E0CF1	POST NO MEMORY	Main-memory refresh verification failure.	Ensure that all banks contain memory modules of the same type and size and that they are properly installed. If the problem persists, see <a href="#">Troubleshooting System Memory</a> in "Troubleshooting Your System."
E0CF5	LOG DISABLE SBE	Multiple single-bit errors on a single memory module.	See <a href="#">Troubleshooting System Memory</a> in "Troubleshooting Your System."
E0D76	DRIVE FAIL	Faulty or improperly installed hard drive or RAID controller.	See <a href="#">Troubleshooting Hard Drives</a> and <a href="#">Troubleshooting a RAID Controller Card</a> in "Troubleshooting Your System."
E0F04	POST CMOS	CMOS write/read failure; faulty system board.	See <a href="#">Getting Help</a> .
E0F04	POST CPU SPEED	Microprocessor speed control sequence failure.	See <a href="#">Getting Help</a> .
E0F04	POST DMA INIT	DMA initialization failure; DMA page register write/read failure.	See <a href="#">Troubleshooting System Memory</a> in "Troubleshooting Your System."
E0F04	POST DMA REG	Faulty system board.	See <a href="#">Getting Help</a> .
E0F04	POST KYB CNTRL	Faulty keyboard controller; faulty system board.	See <a href="#">Getting Help</a> .
E0F04	POST MEM RFSH	Main-memory refresh verification failure.	See <a href="#">Troubleshooting System Memory</a> in "Troubleshooting Your System."
E0F04	POST PIC REG	Master or slave PIC register test failure.	See <a href="#">Getting Help</a> .
E0F04	POST SHADOW	BIOS-shadowing failure.	See <a href="#">Troubleshooting System Memory</a> in "Troubleshooting Your System."
E0F04	POST SHD TEST	Shutdown test failure.	
E0F04	POST SIO	Super I/O chip failure; faulty system board.	See <a href="#">Getting Help</a> .
E0F04	POST TIMER	Programmable interval timer test failure; faulty system board.	See <a href="#">Getting Help</a> .
E0F0B	POST ROM CHKSUM	Faulty or improperly installed expansion card.	See <a href="#">Troubleshooting Expansion Cards</a> in "Troubleshooting Your System."
E0F0C	VID MATCH CPU <i>n</i>	Specified microprocessor is faulty, unsupported, improperly installed, or missing.	See <a href="#">Troubleshooting a Microprocessor</a> in "Troubleshooting Your System."
E10F3	LOG DISABLE	BIOS disabled logging errors.	Check the SEL for details on the errors.

	BIOS		
E13F2	IO CHANNEL CHECK	Faulty or improperly installed expansion card; faulty system board.	See " <a href="#">Troubleshooting Expansion Cards</a> " in "Troubleshooting Your System."
E13F4	PCI PARITY		
E13F5	PCI SYSTEM		
E13F8	CPU BUS INIT	Faulty or improperly installed microprocessor or system board.	See " <a href="#">Troubleshooting a Microprocessor</a> " in "Troubleshooting Your System." If the problem persists, see " <a href="#">Getting Help</a> ."
E13F8	CPU BUS PARITY	Faulty system board.	See " <a href="#">Getting Help</a> ."
E13F8	CPU MCKERR	Machine check error; faulty or improperly installed microprocessor; faulty system board.	See " <a href="#">Troubleshooting a Microprocessor</a> " in "Troubleshooting Your System."
E13F8	HOST BUS	Faulty system board.	See " <a href="#">Getting Help</a> ."
E13F8	HOST TO PCI BUS		
E13F8	MEM CONTROLLER	Faulty or improperly installed memory module; faulty system board.	See " <a href="#">Troubleshooting System Memory</a> " in "Troubleshooting Your System."
E1580	POWER CONTROL	Faulty system board.	See " <a href="#">Getting Help</a> ."
E20F1	OS HANG	Operating system watchdog timer timed out.	Restart your system. If the problem persists, see your operating system documentation.
EFFF0	RAC ERROR	Remote access controller firmware failure; faulty system board.	See " <a href="#">Getting Help</a> ."
EFFF1	POST ERROR	BIOS error.	Update the BIOS firmware (see " <a href="#">Getting Help</a> ").
EFFF2	BP ERROR	Faulty or improperly installed backplane board.	Ensure that the interface cables are securely connected to the backplane board (see " <a href="#">Installing Drives</a> "). If the problem persists, see " <a href="#">Getting Help</a> ."

**NOTE:** For the full name of an abbreviation or acronym used in this table, see "[Abbreviations and Acronyms](#)."

## Solving Problems Described by LCD Status Messages

When a single message appears on the status LCD, locate the code in [Table 2-9](#) and perform the suggested corrective action. The code on the LCD can often specify a very precise fault condition that is easily corrected. For example, if the code E0280 MISSING VRM 2 appears, you know that a microprocessor is installed in socket 2, but the VRM for that microprocessor is either improperly installed or missing.

In contrast, you might be able to determine the problem if multiple related errors occur. For example, if you receive a series of messages indicating multiple voltage faults, you might determine that the problem is a failing power supply.

## Removing LCD Status Messages

For faults associated with sensors, such as temperature, voltage, fans, and so on, the LCD message is automatically removed when that sensor returns to a normal state. For example, if temperature for a component goes out of range, the LCD displays the fault; when the temperature returns to the acceptable range, the message is removed from the LCD. For other faults, you must take action to remove the message from the display:

- 1 Clear the SEL — You can perform this task remotely, but you will lose the event history for the system.
- 1 Chassis intrusion — When you remove the cover, the system assumes that you are servicing the bad component; the LCD clears when you replace the cover.
- 1 Power cycle — Turn off the system and disconnect it from the electrical outlet; wait approximately ten seconds, reconnect the power cable, and restart the system.

Any of these actions will remove fault messages, and return the status indicators and LCD colors to the normal state. Messages will reappear under the following conditions:

- 1 The sensor returns to a normal state but fails again, resulting in a new SEL entry.
- 1 The system is reset and new error events are detected.
- 1 A failure is recorded from another source that maps to the same display entry.

## System Messages

System messages appear on the console during POST to notify you of a possible problem with the system. If you are performing console redirection, system messages will appear on the remote console. [Table 2-10](#) lists the system messages that can occur and the probable cause for each message.

 **NOTE:** If you receive a system message that is not listed in [Table 2-10](#), check the documentation for the application program that is running when the message appears or the operating system's documentation for an explanation of the message and recommended action.

 **NOTE:** Before you perform any procedures described in [Table 2-10](#), see "[Before You Begin](#)" in "Troubleshooting Your System."

**Table 2-10. System Messages**

Message	Causes	Corrective Actions
Address mark not found	Faulty CD/diskette drive subsystem or hard-drive subsystem; faulty system board.	See " <a href="#">Troubleshooting the Diskette Drive</a> ," " <a href="#">Troubleshooting a CD Drive</a> ," and " <a href="#">Troubleshooting Hard Drives</a> " in "Troubleshooting Your System."
Alert! Current configuration does not support	Memory modules installed are not the	Ensure that all banks contain memory modules of the same

redundant memory. Redundant memory is disabled.	same type and size in all banks; faulty memory module(s).	type and size and that they are properly installed. If the problem persists, see " <a href="#">Troubleshooting System Memory</a> " in "Troubleshooting Your System."
Alert! Unsupported memory or incomplete sets in the following bank(s): Bank x	Memory modules installed in the specified bank are not the same type and size; faulty memory module(s).	Ensure that all banks contain memory modules of the same type and size and that they are properly installed. If the problem persists, see " <a href="#">Troubleshooting System Memory</a> " in "Troubleshooting Your System."
Amount of available memory limited to 256 MB!	<b>OS Install Mode</b> is enabled in the System Setup program.	Disable <b>OS Install Mode</b> in the System Setup program (see "Using the System Setup program" in the <i>User's Guide</i> ).
Auxiliary device failure	Loose or improperly connected mouse or keyboard cable; faulty mouse or keyboard.	See " <a href="#">Troubleshooting the Mouse</a> " and " <a href="#">Troubleshooting the Keyboard</a> " in "Troubleshooting Your System."
BIOS Update Attempt Failed!	Remote BIOS update attempt failed.	Retry the BIOS update. If problem persists, see " <a href="#">Getting Help</a> ."
CD-ROM drive not found	Improperly connected or missing CD drive.	See " <a href="#">Troubleshooting a CD Drive</a> " in "Troubleshooting Your System."
CPUs with different cache sizes detected	Microprocessors with different cache sizes are installed.	Ensure that all microprocessors have the same cache size and that they are properly installed (see " <a href="#">Adding or Replacing a Microprocessor</a> " in "Installing System Options").
Decreasing available memory	Faulty or improperly installed memory modules.	See " <a href="#">Troubleshooting System Memory</a> " in "Troubleshooting Your System."
Diskette drive n seek failure	Incorrect configuration settings in the System Setup program. Faulty or improperly installed diskette drive.	Run the System Setup program to correct the settings (see "Using the System Setup Program" in the <i>User's Guide</i> ). See " <a href="#">Troubleshooting the Diskette Drive</a> " in "Troubleshooting Your System."
Diskette read failure	Faulty or improperly inserted diskette.	Replace the diskette.
Diskette subsystem reset failed	Faulty or improperly installed diskette drive.	See " <a href="#">Troubleshooting the Diskette Drive</a> " in "Troubleshooting Your System."
ECC memory error	Faulty or improperly installed memory modules.	See " <a href="#">Troubleshooting System Memory</a> " in "Troubleshooting Your System."
Remote access controller error	Embedded remote access memory may be temporarily corrupted.	To clear the embedded remote access memory, shut down the system, disconnect the power cords, wait approximately 30 seconds, reconnect the power cords, and restart the system. If the problem persists, see " <a href="#">Getting Help</a> ."
Remote access controller is not present		
Error: Maximum PCI option ROM count exceeded!	Too many expansion cards have ROM enabled in the System Setup program.	Disable ROM for some of the expansion cards. See "Using the System Setup Program" in the <i>User's Guide</i> .
Gate A20 failure	Faulty keyboard controller; faulty system board.	See " <a href="#">Getting Help</a> ."
Hard disk controller failure	Incorrect configuration settings in System Setup program; improperly installed hard drive, or loose interface or power cable; faulty hard-drive controller subsystem.	Run the System Setup program to correct the drive type (see "Using the System Setup Program" in the <i>User's Guide</i> ). If the problem persists, see " <a href="#">Troubleshooting Hard Drives</a> " in "Troubleshooting Your System."
Hard disk read failure		
I/O parity interrupt at address	Faulty or improperly installed expansion card.	See " <a href="#">Troubleshooting Expansion Cards</a> " in "Troubleshooting Your System."
Invalid configuration information - please run SETUP program	Incorrect configuration settings in System Setup program; NVRAM_CLR jumper is installed; faulty system battery.	Check the System Setup configuration settings (see "Using the System Setup Program" in the <i>User's Guide</i> ). Remove the NVRAM_CLR jumper (see <a href="#">Figure A-2</a> for jumper location). If the problem persists, see " <a href="#">Troubleshooting the System Battery</a> " in "Troubleshooting Your System."
Invalid NVRAM configuration, resource re-allocated	System configuration data has been ignored.	Check the System Setup configuration settings. See "Using the System Setup Program" in the <i>User's Guide</i> .
Invalid SCSI configuration	A SCSI cable is connected to the channel B connector on the SCSI backplane board; SCSI backplane daughter card is not installed.	If a cable is connected to the SCSIIB backplane board connector, the SCSI backplane daughter card must be installed. Install the backplane daughter card (see " <a href="#">Installing a SCSI Backplane Daughter Card</a> " in "Installing Drives").
SCSI cable detected on connector SCSIIB of the SCSI backplane, daughter card not present		
Keyboard controller failure	Faulty keyboard controller; faulty system board.	See " <a href="#">Getting Help</a> ."
Keyboard clock line failure	Loose or improperly connected keyboard cable; faulty keyboard; faulty keyboard controller.	See " <a href="#">Troubleshooting the Keyboard</a> " in "Troubleshooting Your System."
Keyboard data line failure		
Keyboard failure		
Keyboard stuck key failure		
Memory address line failure at address, read value expecting value	Faulty or improperly installed memory modules.	See " <a href="#">Troubleshooting System Memory</a> " in "Troubleshooting Your System."
Memory double word logic failure at address, read value expecting value		
Memory high address line failure at start address to end address		
Memory high data line failure at start address to end address		
Memory odd/even logic failure at start address to end address		
Memory write/read failure at address, read value		



expecting value		
Memory parity failure at <i>start address</i> to <i>end address</i>	Faulty or improperly installed memory modules.	See " <a href="#">Troubleshooting System Memory</a> " in "Troubleshooting Your System."
Memory parity error at <i>address</i>		
No boot device available	Faulty or missing CD/diskette drive subsystem, hard drive, or hard-drive subsystem.	Use a bootable diskette, CD, or hard drive. If the problem persists, see " <a href="#">Troubleshooting the Diskette Drive</a> ," " <a href="#">Troubleshooting a CD Drive</a> ," and " <a href="#">Troubleshooting Hard Drives</a> " in "Troubleshooting Your System."
No boot sector on hard- disk	No operating system on hard drive.	Check the hard-drive configuration settings in the System Setup program (see "Using the System Setup Program" in the <i>User's Guide</i> ).
No PXE-capable device available	<F12> pressed during POST and no PXE devices are detected.	Check the configuration settings in the System Setup program for the NICs (see "Using the System Setup Program" in the <i>User's Guide</i> ). If the problem persists, see " <a href="#">Troubleshooting the NICs</a> " in "Troubleshooting Your System."
No timer tick interrupt	Faulty system board.	See " <a href="#">Getting Help</a> ."
Not a boot diskette	No operating system on diskette.	Use a bootable diskette.
PCI BIOS failed to install	Loose cables to expansion card(s); faulty or improperly installed expansion card.	Ensure that all appropriate cables are securely connected to the expansion cards. If the problem persists, see " <a href="#">Troubleshooting Expansion Cards</a> " in "Troubleshooting Your System."
Plug & Play Configuration Error Embedded xxx	Error encountered in initializing PCI device; faulty system board.	Install the NVRAM_CLR jumper and reboot the system (see <a href="#">Figure A-2</a> for jumper location). If the problem persists, see " <a href="#">Troubleshooting Expansion Cards</a> " in "Troubleshooting Your System."
Plug & Play Configuration Error PCI_n	Error encountered in initializing PCI adapter.	
Primary backplane is not present	Faulty or improperly installed SCSI backplane board.	See " <a href="#">Getting Help</a> ."
Processor <i>n</i> internal error	Faulty microprocessor; faulty system board.	See " <a href="#">Troubleshooting a Microprocessor</a> " in "Troubleshooting Your System."
Processor bus parity error		
Processor in socket 1 not installed!	No microprocessor installed in primary microprocessor socket.	Install a microprocessor in the primary microprocessor socket. Also, ensure that a VRM for processor 1 is installed (see " <a href="#">Adding or Replacing a Microprocessor</a> " in "Installing System Options").
SCSI cable not present on connector A or B of the primary backplane	SCSI cable is loose, improperly connected, or faulty.	Check the SCSI cable connection. If problem persists, add or replace SCSI cable (see " <a href="#">Getting Help</a> ").
Shutdown failure	Shutdown test failure.	See " <a href="#">Troubleshooting System Memory</a> " in "Troubleshooting Your System."
System backplane error	Faulty or improperly installed SCSI backplane board.	See " <a href="#">Getting Help</a> ."
System halted! Must power down	Wrong password entered too many times.	Information only.
Time-of-day clock stopped	Faulty battery.	See " <a href="#">Troubleshooting the System Battery</a> " in "Troubleshooting Your System."
Time-of-day not set - please run SETUP program	Incorrect Time or Date settings; faulty system battery.	Check the Time and Date settings (see "Using the System Setup Program" in the <i>User's Guide</i> ). If the problem persists, replace the system battery (see " <a href="#">Replacing the System Battery</a> " in "Installing System Options").
Timer chip counter 2 failed	Faulty system board.	See " <a href="#">Getting Help</a> ."
Unsupported CPU combination	Microprocessor(s) is not supported by the system.	Install a supported microprocessor combination (see " <a href="#">Adding or Replacing a Microprocessor</a> " in "Installing System Options").
Unsupported CPU stepping detected		
Unsupported DIMM detected in the RAID DIMM slot!	RAID memory module is not supported by the system.	Install a correct version of the RAID memory module (see " <a href="#">Activating the Integrated RAID Controller</a> " in "Installing Drives").
Unsupported RAID key detected!	RAID hardware key is not supported by the system.	Install the RAID hardware key for your specific system (see " <a href="#">Activating the Integrated RAID Controller</a> " in "Installing Drives").
Utility partition not available	The <F10> key was pressed during POST, but no utility partition exists on the boot hard drive.	Create a utility partition on the boot hard drive (see "Using the Dell OpenManage Server Assistant CD" in your <i>User's Guide</i> ).
The VRM for the processor in socket <i>n</i> is not installed.	Specified microprocessor VRM is faulty, unsupported, improperly installed, or missing.	Ensure that supported VRMs of the same type are properly installed. If the problem persists, replace the VRM (see <a href="#">Figure 6-9</a> ).
Warning: Detected mode change from RAID to SCSI B of the embedded RAID subsystem.	Type of controller has changed since previous system boot.	Back up information on the hard drives before changing the type of controller used with the drives.
Warning: Detected missing RAID hardware for the embedded RAID subsystem. Data loss will occur! Press Y to switch mode to SCSI, press any other key to disable both channels. Press Y to confirm the change; press any other key to cancel.		
Warning: Firmware is out- of-date, please update.	Firmware error.	Update the firmware (see " <a href="#">Getting Help</a> ").
Warning! No microcode update loaded for processor X	BIOS error.	Update the BIOS firmware (see " <a href="#">Getting Help</a> ").
Write fault	Faulty diskette, CD/diskette drive assembly, hard drive, or hard-drive subsystem.	See " <a href="#">Troubleshooting the Diskette Drive</a> ," " <a href="#">Troubleshooting a CD Drive</a> ," and " <a href="#">Troubleshooting Hard Drives</a> " in "Troubleshooting Your System."
Write fault on selected drive		

**NOTE:** For the full name of an abbreviation or acronym used in this table, see "[Abbreviations and Acronyms](#)."

## System Beep Codes

When an error that cannot be reported on the monitor occurs during a boot routine, the system may emit a series of beeps that identifies the problem.

When a beep code is emitted, record it on a copy of the Diagnostics Checklist in "[Getting Help](#)," and then look it up in [Table 2-11](#). If you are unable to resolve the problem by looking up the meaning of the beep code, use the system diagnostics to identify a more serious cause. If you are still unable to resolve the problem, see "[Getting Help](#)."

 **NOTE:** If the system boots without a keyboard, mouse, or monitor attached, the system will not issue beep codes related to those peripherals.

 **NOTE:** Before you perform any procedures described in [Table 2-11](#), see "[Before You Begin](#)" in "Troubleshooting Your System."

**Table 2-11. System Beep Codes**

Code	Cause	Corrective Action	
1-1-2	CPU register test failure.	Replace microprocessor 1. See " <a href="#">Adding or Replacing a Microprocessor</a> " in "Installing System Board Options." If the problem persists, replace microprocessor 2.	
1-1-3	CMOS write/read failure; faulty system board.	See " <a href="#">Getting Help</a> ."	
1-1-4	BIOS error.	Reflash the BIOS firmware (see " <a href="#">Getting Help</a> ").	
1-2-1	Programmable interval-timer failure; faulty system board.	See " <a href="#">Getting Help</a> ."	
1-2-2	DMA initialization failure.	See " <a href="#">Troubleshooting System Memory</a> " in "Troubleshooting Your System."	
1-2-3	DMA page register write/read failure.		
1-3-1	Main-memory refresh verification failure.		
1-3-2	No memory installed.		
1-3-3	Chip or data line failure in the first 64 KB of main memory.		
1-3-4	Odd/even logic failure in the first 64 KB of main memory.		
1-4-1	Address line failure in the first 64 KB of main memory.		
1-4-2	Parity failure in the first 64 KB of main memory.		
1-4-3	Fail-safe timer test failure.		
1-4-4	Software NMI port test failure.		
2-1-1 through 2-4-4	Bit failure in the first 64 KB of main memory.		
3-1-1	Slave DMA-register failure.		See " <a href="#">Getting Help</a> ."
3-1-2	Master DMA-register failure.		
3-1-3	Master interrupt-mask register failure.		
3-1-4	Slave interrupt-mask register failure.		
3-2-2	Interrupt vector loading failure.		
3-2-4	Keyboard-controller test failure.	See " <a href="#">Troubleshooting the Keyboard</a> " in "Troubleshooting Your System."	
3-3-1	CMOS failure.	See " <a href="#">Getting Help</a> ."	
3-3-2	System configuration check failure.		
3-3-3	Keyboard controller not detected.		
3-3-4	Video memory test failure.		
3-4-1	Screen initialization failure.		
3-4-2	Screen-retrace test failure.		
3-4-3	Video ROM search failure.		
4-2-1	No timer tick.		
4-2-2	Shutdown test failure.		
4-2-3	Gate A20 failure.		
4-2-4	Unexpected interrupt in protected mode.		See " <a href="#">Troubleshooting Expansion Cards</a> " in "Troubleshooting Your System."
4-3-1	Improperly installed or faulty memory modules.		See " <a href="#">Troubleshooting System Memory</a> " in "Troubleshooting Your System."
4-3-2	No memory modules installed in bank 1.		Install memory modules in bank 1 of the same type and size (see " <a href="#">Installing Memory Modules</a> " in "Installing System Options").
4-3-3	Faulty system board.	See " <a href="#">Getting Help</a> ."	
4-3-4	Time-of-day clock stopped.	See " <a href="#">Troubleshooting the System Battery</a> " in "Troubleshooting Your System."	

4-4-1	Super I/O chip failure; faulty system board.	See " <a href="#">Getting Help</a> ."
4-4-2	BIOS-shadowing failure.	See " <a href="#">Troubleshooting System Memory</a> " in "Troubleshooting Your System."
4-4-3	Microprocessor speed control sequence failure.	See " <a href="#">Troubleshooting a Microprocessor</a> " in "Troubleshooting Your System."
4-4-4	Cache test failure; faulty microprocessor.	

**NOTE:** For the full name of an abbreviation or acronym used in this table, see "[Abbreviations and Acronyms](#)."

---

## Warning Messages

A warning message alerts you to a possible problem and asks you to take corrective action before the system continues a task. For example, before you format a diskette, a message may warn you that you may lose all data on the diskette. Warning messages usually interrupt the procedure and require you to respond by typing y (yes) or n (no).

 **NOTE:** Warning messages are generated by either the application program or the operating system. For more information, see "[Finding Software Solutions](#)" and the documentation that accompanied the operating system or application program.

---

## Diagnostics Messages

When you run a test group or subtest in system diagnostics, an error message may result. Diagnostic error messages are not covered in this section. Record the message on a copy of the Diagnostics Checklist (see "[Getting Help](#)"), and then follow the instructions in that section for obtaining technical assistance.

---

## Alert Messages

The optional systems management software generates alert messages for your system. For example, the software generates messages that appear in the SNMP trap log file. Alert messages consist of information, status, warning, and failure messages for drive, temperature, fan, and power conditions. For more information, see the systems management software documentation.

---

[Back to Contents Page](#)

[Back to Contents Page](#)

## Finding Software Solutions

### Dell™ PowerEdge™ 2650 Systems Installation and Troubleshooting Guide

- [Installing and Configuring Software](#)
- [Using Software](#)

Because most systems have several application programs installed in addition to the operating system, isolating a software problem can be confusing. Software errors can also appear to be hardware malfunctions at first.

Software problems can result from the following circumstances:

- 1 Improper installation or configuration of a program
- 1 Input errors
- 1 Device drivers that may conflict with certain application programs
- 1 Interrupt conflicts between devices

You can confirm that a system problem is caused by software by running system diagnostics. If all tests in the test group are completed successfully, the problem is most likely caused by software.

This section provides some general guidelines for analyzing software problems. For detailed troubleshooting information on a particular program, see the documentation that accompanied the software or consult the support service for the software.

---

## Installing and Configuring Software

Use virus-scanning software to check newly acquired programs and files for viruses before installing the programs on the system's hard drive. Viruses can quickly use all available system memory, damage or destroy data stored on the hard drive, and permanently affect the performance of the programs they infect. Several commercial virus-scanning programs are available for purchase.

Before installing a program, read its documentation to learn how the program works, what hardware it requires, and what its defaults are. A program usually includes installation instructions in its accompanying documentation and a software installation routine.

The software installation routine assists users in transferring the appropriate program files to the system's hard drive. Installation instructions may provide details about how to configure the operating system to successfully run the program. Always read the installation instructions before running a program's installation routine.

When you run the installation routine, be prepared to respond to prompts for information about how the system's operating system is configured, what type of system you have, and what peripherals are connected to the system.

---

## Using Software

The following subsections discuss errors that can occur as a result of software operation or configuration.

### Error Messages

Error messages can be produced by an application program, the operating system, or the system. "[Indicators, Messages, and Codes](#)" discusses the error messages that are generated by the system. If you receive an error message that is not listed in "[Indicators, Messages, and Codes](#)," check the operating system or application program documentation.

### Input Errors

If a specific key or set of keys is pressed at the wrong time, a program may give you unexpected results. See the documentation that came with the application program to make sure that the values or characters you are entering are valid.

Ensure that the operating environment is set up to accommodate the programs you use. Remember that whenever you change the parameters of the system's operating environment, you may affect the successful operation of the programs. Sometimes, after modifying the operating environment, you may need to reinstall a program that no longer runs properly.

### Program Conflicts

Some programs may leave portions of their setup information behind, even though you have exited from them. As a result, other programs cannot run. Rebooting the system can confirm whether these programs are the cause of the problem.

Device drivers, which are programs that use specialized subroutines, can cause problems with the system. For example, a variation in the way the data is sent to the monitor may require a special screen driver program that expects a certain kind of video mode or monitor. In such cases, you may have to develop an alternate method of running that particular program—by creating a start-up file made especially for that program, for example. Contact the support service for the software you are using to help you with this problem.

### Avoiding Interrupt Assignment Conflicts

Most PCI devices can share an IRQ line with another device. However, no two devices can use the IRQ line simultaneously. Problems can arise if a PCI device cannot share an IRQ line or if two devices attempt to use the same IRQ line simultaneously. To avoid this type of conflict, see the documentation for each installed expansion card. See [Table 3-1](#) to configure the card for one of the available IRQ lines.

**Table 3-1. IRQ Line Assignment Defaults**

IRQ Line	Used By/Available
IRQ0	Used by the system timer
IRQ1	Used by the keyboard controller
IRQ2	Used by interrupt controller 1 to enable IRQ8 through IRQ15
IRQ3	Used by serial port 2 (COM2 and COM4)
IRQ4	Used by serial port 1 (COM1 and COM3)
IRQ5	Available
IRQ6	Used by the diskette drive controller
IRQ7	Available
IRQ8	Used by the real-time clock
IRQ9	Used for power management functions
IRQ10	Available
IRQ11	Available
IRQ12	Used by the PS/2 mouse port unless the mouse is disabled in the System Setup program
IRQ13	Used by the math coprocessor
IRQ14	IDE CD drive controller
IRQ15	Available

**NOTE:** For the full name of an abbreviation or acronym used in this table, see "[Abbreviations and Acronyms](#)."

---

[Back to Contents Page](#)

[Back to Contents Page](#)

## Running System Diagnostics

Dell™ PowerEdge™ 2650 Systems Installation and Troubleshooting Guide

- [Features of the System Diagnostics](#)
- [When to Use the System Diagnostics](#)
- [Starting System Diagnostics](#)
- [Using the System Diagnostics](#)
- [Using the Device Groups Menu](#)
- [Device Groups Menu Options](#)
- [Error Messages](#)

Unlike many diagnostic programs, the system diagnostics helps you check the system's hardware without any additional equipment and without destroying any data. By using the system diagnostics, you can have confidence in the system's operation. If you find a problem that you cannot solve by yourself, the diagnostic tests can provide you with important information you will need when talking to a technical assistance representative.

 **NOTICE:** Use the system diagnostics to test only Dell systems. If you use this program with other systems, incorrect system responses or error messages may result.

---

### Features of the System Diagnostics

The system diagnostics provides a series of menus and options from which you choose particular device groups or devices. You can also control the sequence in which the tests are run. The diagnostic menus also have these helpful features:

- 1 Options that let you run tests individually or collectively
  - 1 An option that allows you to choose the number of times a test is repeated
  - 1 The ability to display or print test results or to save them in a file
  - 1 Options to temporarily suspend testing if an error is detected or to terminate testing when an adjustable error limit is reached
  - 1 Help messages that briefly describe each test and its parameters
  - 1 Status messages that inform you whether device group or device tests are completed successfully
  - 1 Error messages that appear if any problems are detected
- 

### When to Use the System Diagnostics

Whenever a major component or device in the system does not function properly, you may have a component failure. As long as the microprocessor and the input and output components of the system (the monitor, keyboard, and diskette drive) are working, you can use system diagnostics. If you know what component(s) you need to test, select the appropriate diagnostic device group(s) or subtest(s). If you are unsure about the scope of the problem, read the remainder of the information in this section.

---

### Starting System Diagnostics

You can run system diagnostics from either the utility partition on your hard drive or from a set of diskettes that you create from the *Dell OpenManage Server Assistant CD*.

To run the diagnostics from the utility partition, perform the following steps:

1. Start the utility partition by pressing <F10> during POST.
2. From the utility partition's main menu, select the **Run System Diagnostics** option from **Run System Utilities**. See "Utility Partition" in "Using the Dell OpenManage Server Assistant CD" in the *User's Guide* for additional information about the utility partition.

To run the system diagnostics from the diskettes, perform the following steps:

1. Create a set of diagnostics diskettes using the *Dell OpenManage Server Assistant CD*. See "Using the Dell OpenManage Server Assistant CD" in the *User's Guide* for information on creating diskettes.
2. Boot the system from the first diagnostics diskette.

If the system fails to boot, see "[Getting Help](#)."

When you start the system diagnostics, a message is displayed telling you that the diagnostics is loading. The **Diagnostics** menu appears. The menu allows you to run all or specific diagnostic tests or to exit system diagnostics.

 **NOTE:** Before you read the rest of this section, start the system diagnostics so that you can see it on your monitor screen.

For a quick check of the system, select **Test All Devices** and then select **Quick Tests**. This option runs only the device tests that do not require user interaction and that do not take a long time to run. Dell recommends that you choose this option first to increase the chance of tracing the source of the problem quickly. To test a particular device, select **Test One Device**. For a complete check of the system, select **Test All Devices** and then select **Extended Tests**.

To check a particular area of the system, choose **Advanced Testing**. When you select **Advanced Testing**, the main screen of the diagnostics appears. This screen includes a listing of the various device groups in the system and the system's service tag.

To view data on test results, select **Information and Results**. Select **Program Options** to view the program options screen, which lets you set various test parameters.

By selecting the **Device Configuration** option, you can see an overview of the devices in the system.

Selecting **Exit to MS-DOS** exits the diagnostics and returns you to the MS-DOS® operating system environment.

To select an option from the **Diagnostics** menu, highlight the option and press <Enter>, or press the key that corresponds to the highlighted letter in the option you choose.

---

## Using the System Diagnostics

When you select **Advanced Testing** from the **Diagnostics** menu, the main screen of the diagnostics appears.

Information on the main screen of the diagnostics is presented in the following areas:

- 1 Two lines at the top of the main screen identify the diagnostics, the version number, and the system service tag.
  - 1 On the left side of the screen, **Device Groups** lists the diagnostic device groups in the order they will run if you select **All** under the **Run Tests** submenu. Press the up- or down-arrow key to highlight a device group.
  - 1 On the right side of the screen, **Devices for Highlighted Group** lists the specific devices within a particular test group.
  - 1 Two lines at the bottom of the screen make up the menu area. The first line lists the menu options you can select; press the left- or right-arrow key to highlight an option. The second line gives information about the highlighted option.
- 

## Using the Device Groups Menu

The **Device Groups** menu at the bottom of the screen provides options that enable you to select and run specific diagnostic tests from the diagnostics main screen. Press the left- and right-arrow keys to select the options on the menu. As you move from one menu option to another, a brief explanation of the highlighted option appears on the bottom line of the screen.

If you want more information about a device group or device, highlight the **Help** option and press <Enter>. After you read the information, press <Esc> to return to the previous screen.

---

## Device Groups Menu Options

Five options are listed at the bottom of the diagnostics main screen: **Run Tests**, **Devices**, **Select**, **Config**, and **Help**.

There are two ways to select a menu option:

- 1 Look on the screen to see which letter in the option is capitalized, and type that letter (for example, type r to select the **Run** option).
- 1 Move the highlight to the option you want to select by pressing the left- or right-arrow key, and then press <Enter>.

Whenever one of the options is selected, additional choices become available.

The following subsections explain the menu options as listed from left to right in the **Device Groups** menu.

### Run Tests

Run Tests displays seven options:

- 1 **One** — Runs all the devices within the highlighted device group.
- 1 **All** — Runs all of the tests in all of the device group tests (device group tests are run in the same order that they are listed).
- 1 **Select** — Runs only the selected device groups or the devices that you selected within the device groups.
- 1 **Options** — Provides a set of global parameters that allow you control over how the device group tests or device tests are run and how results are reported.
- 1 **Results** — Displays the results of the tests.
- 1 **Errors** — Displays errors detected during the tests.
- 1 **Help** — Displays a series of help options, including **Menu**, **Keys**, **Device Group**, **Device**, **Test**, and **Versions**.

### Devices

Most of the device groups consist of several devices. Use the **Devices** option to select individual devices within the device group(s).

When you select **Devices**, the following options are displayed: **Run Tests**, **Tests**, **Select**, **Parameters**, and **Help**. [Table 4-1](#) lists all of the possible values for each option.

Table 4-1. Devices Options

Option	Functions
Run Tests	Displays seven options: <b>One, All, Select, Options, Results, Errors, and Help.</b>
Tests	Allows you to select individual devices to tailor the testing process to your particular needs. You can choose one or more devices from the list. When you choose <b>Tests</b> , four options are displayed: <b>Run Tests, Select, Parameters, and Help.</b>
Select	Allows you to choose one or more devices from a particular device group. Three options are displayed: <b>One, All, and Help.</b>
Parameters	Determines how a particular test will be run.
Help	Displays a list of help topics.

## Select

The **Select** option in the **Device Groups** menu allows you to choose one or more devices from a particular device group. Three options are displayed: **One, All, and Help.**

## Config

Choosing **Config** from the **Device Groups** menu displays information about the particular device that is highlighted.

---

## Error Messages

When you run a test in the diagnostics, error messages may result. Record the messages on a copy of the Diagnostics Checklist; see "[Getting Help](#)" for instructions on obtaining technical assistance and informing the technical assistance representative of the messages.

---

[Back to Contents Page](#)



[Back to Contents Page](#)

## Troubleshooting Your System

### Dell™ PowerEdge™ 2650 Systems Installation and Troubleshooting Guide

- [Safety First—For You and Your System](#)
- [Before You Begin](#)
- [External Connections](#)
- [Checking Specific System Problems](#)
- [Start-Up Routine](#)
- [System Orientation](#)
- [Bezel](#)
- [System Cover](#)
- [Checking the Equipment](#)
- [Inside the System](#)
- [Responding to a Systems Management Alert Message](#)
- [Troubleshooting a Wet System](#)
- [Troubleshooting a Damaged System](#)
- [Troubleshooting the System Battery](#)
- [Troubleshooting Power Supplies](#)
- [Troubleshooting System Cooling](#)
- [Troubleshooting a Microprocessor](#)
- [Troubleshooting Expansion Cards](#)
- [Troubleshooting System Memory](#)
- [Troubleshooting the Diskette Drive](#)
- [Troubleshooting a CD Drive](#)
- [Troubleshooting an External SCSI Tape Drive](#)
- [Troubleshooting Hard Drives](#)
- [Troubleshooting the Integrated RAID Controller](#)
- [Troubleshooting a RAID Controller Card](#)

If your system is not working as expected, begin troubleshooting using the procedures in this section. This section guides you through some initial checks and procedures that can solve basic system problems and provides troubleshooting procedures for components inside the system. Before you start any of the procedures in this section, take the following steps:

- 1 Read the "Safety Instructions" in your *System Information* document.
- 1 Read "[Running System Diagnostics](#)" for information about running diagnostics.
- 1 Get the key to the system keylock and the system back cover.

---

## Safety First—For You and Your System

The procedures in this guide require that you remove the cover and work inside the system. While working inside the system, do not attempt to service the system except as explained in this guide and elsewhere in your system documentation. Always follow the instructions closely. Ensure that you review all of the procedures in "Safety Instructions" in your *System Information* document.

Working inside the system is safe—if you observe the following precautions.

 **CAUTION:** The power supplies in this system produce high voltages and energy hazards, which can cause bodily harm. Only trained service technicians are authorized to remove the system cover and access any of the components inside the system.

 **NOTICE:** See "Protecting Against Electrostatic Discharge" in the safety instructions in your *System Information* document before performing any procedure which requires you to open the cover.

---

## Before You Begin

Before you perform any of the procedures, ensure that the following components are securely and properly installed:

- 1 Power cables
- 1 Cables to external devices, such as monitor, mouse, keyboard, and so on
- 1 System board tray
- 1 Expansion-card cage

---

## External Connections

Improperly set switches, controls, and loose or improperly connected cables are the most likely source of problems for the system, monitor, or other peripherals (such as a printer, keyboard, mouse, or other external equipment). A quick check of all the switches, controls, and cable connections can easily

solve these problems. See [Figure 2-3](#) for the back-panel features and connectors.

 **NOTE:** To enable the front-panel PS/2 connector, a monitor must be connected to the front-panel video connector. When a monitor is connected to the front panel, the back-panel PS/2 and video connectors are disabled. When no monitor is connected to the system or a monitor is connected to the back panel, the front-panel PS/2 and video connectors are disabled.

---

## Checking Specific System Problems

1. Turn off the system, including any attached peripherals. Disconnect all the power cables from their electrical outlets.
2. If the system is connected to a PDU, turn the PDU off and then on again.

If it is not receiving power, plug it into another electrical outlet. If it still is not receiving power, try another PDU.

3. Reconnect the system to the electrical outlet or PDU.
4. Is the monitor working properly?

See "[Troubleshooting the Video Subsystem](#)."

5. Is the keyboard working properly?

See "[Troubleshooting the Keyboard](#)."

6. Are the mouse and printer working properly?

See "[Troubleshooting the Basic I/O Functions](#)."

---

## Start-Up Routine

Looking at and listening to the system is important in determining the source of a problem. Look and listen during the system's start-up routine for the indication described in Table 5-1.

**Table 5-1. Start-Up Routine Indications**

Look/listen for:	Action
A status or error message displayed on the front-panel LCD	See " <a href="#">LCD Status Messages</a> " in "Indicators, Messages, and Codes."
An error message displayed on the monitor	See " <a href="#">System Messages</a> " in "Indicators, Messages, and Codes."
A series of beeps emitted by the system	See " <a href="#">System Beep Codes</a> " in "Indicators, Messages, and Codes."
Alert messages from the Dell OpenManage™ Server Administrator software	See " <a href="#">Alert Messages</a> " in "Indicators, Messages, and Codes."
The monitor's power indicator	See " <a href="#">Troubleshooting the Video Subsystem</a> ."
The keyboard indicators	See " <a href="#">Troubleshooting the Keyboard</a> ."
The diskette-drive activity indicator	See " <a href="#">Troubleshooting the Diskette Drive</a> ."
The CD drive activity indicator	See " <a href="#">Troubleshooting a CD Drive</a> ."
The hard-drive activity indicators	See " <a href="#">Troubleshooting Hard Drives</a> ."
An unfamiliar constant scraping or grinding sound when you access a drive	See " <a href="#">Getting Help</a> " for instructions on obtaining technical assistance.
<b>NOTE:</b> For the full name of an abbreviation or acronym used in this table, see " <a href="#">Abbreviations and Acronyms</a> ."	

---

## System Orientation

The illustrations in this document are based on the positioning of the system as shown in [Figure 5-1](#).

**Figure 5-1. System Orientation**

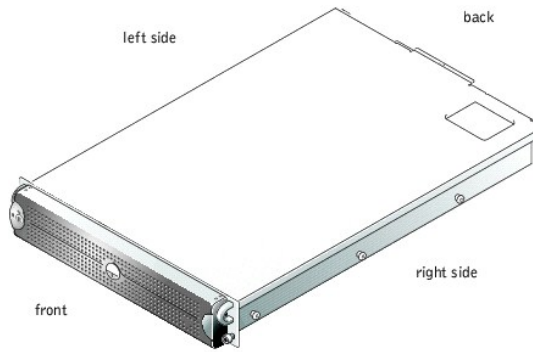

---

## Bezel

The bezel has a system status indicator. A lock on the bezel restricts access to the power button, diskette drive, CD drive, hard drive(s), and the interior of the system.

### Removing the Bezel

1. Using the system key, unlock the bezel.
2. Press the tab at the left end of the bezel.
3. Rotate the left end of the bezel away from the system to release the right end of the bezel.
4. Pull the bezel away from the system (see [Figure 5-2](#)).

**Figure 5-2. Removing the Bezel**

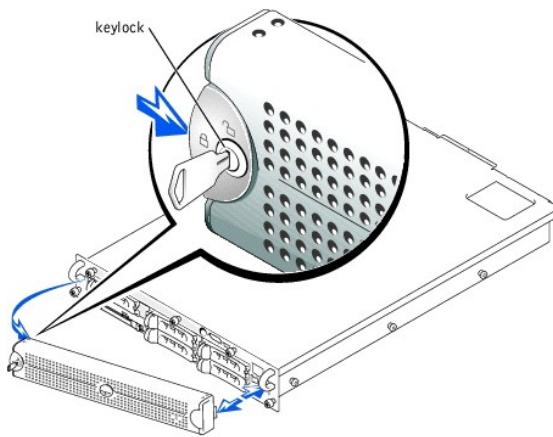

### Replacing the Bezel

1. Fit the tabs on the right end of the bezel into the corresponding slots in the front panel.
2. Rotate the left end of the bezel toward the system to secure the left end of the bezel.
3. Using the system key, lock the bezel.

---

## System Cover

To upgrade or troubleshoot the system, remove the system cover to gain access to internal components.

### Removing the Cover

1. Remove the bezel (see "[Removing the Bezel](#)").

2. Observe the precautions in "[Safety First—For You and Your System.](#)"
3. Loosen the three thumbscrews that secure the cover to the chassis (see [Figure 5-3](#)).
4. Slide the back cover backward and grasp the cover at both ends.
5. Carefully lift the cover away from the system.

**Figure 5-3. Removing the Cover**

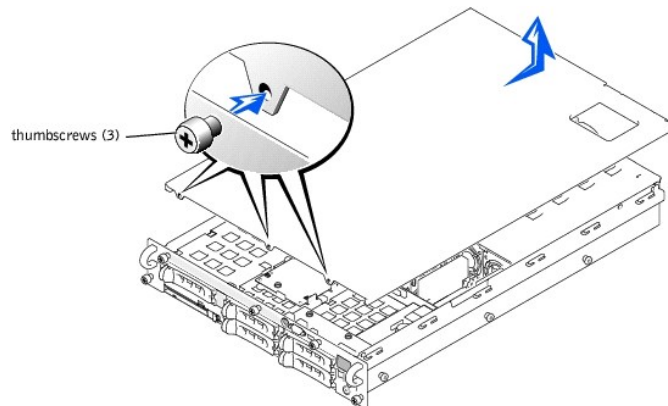

## Replacing the Cover

1. Ensure that no tools or parts are left inside the system and that any cables are routed so that they will not be damaged by the cover.
2. Align the cover with the cover alignment hooks on the sides of the chassis, and slide the cover forward (see [Figure 5-3](#)).
3. Tighten the three thumbscrews that secure the cover to the chassis.
4. Replace the bezel (see "[Replacing the Bezel](#)").

---

## Checking the Equipment

This section provides troubleshooting procedures for external devices that connect to the system, such as the monitor, keyboard, or mouse. Before you perform any of the procedures, see "[External Connections.](#)"

## Troubleshooting the Video Subsystem

### Problem

- 1 Monitor
- 1 Monitor interface cable
- 1 Video memory
- 1 Video logic

### Action

1. Determine whether the system has monitors attached to both the front and rear video connectors.

The system supports only one monitor attached to either the front or rear video connector. When a monitor is connected to the front panel, the back-panel video, and PS/2 keyboard and mouse connectors are disabled.

If two monitors are attached to the system, disconnect one monitor. If the problem is not resolved, continue to step 2.

2. Check the system and power connections to the monitor.
3. Run the video tests in system diagnostics.

If the tests run successfully, the problem is not related to video hardware. Go to "[Finding Software Solutions.](#)"

If the tests did not run successfully, see "[Getting Help](#)" for instructions on obtaining technical assistance.

## Troubleshooting the Keyboard

### Problem

- 1 System error message indicates a keyboard problem

## Action

1. Determine whether the system has monitors attached to both the front and rear video connectors.

The system supports only one monitor attached to either the front or rear video connector. When a monitor is connected to the front panel, the back-panel video, and PS/2 keyboard and mouse connectors are disabled.

If two monitors are attached to the system, disconnect one monitor. If the problem is not resolved, continue to step 2.

2. Look at the keyboard and the keyboard cable for any signs of damage.

If the keyboard and its cable appear to be free of physical damage, and the keys work, go to step 4.

If the keyboard or its cable are damaged, continue to step 3.

3. Swap the faulty keyboard with a working keyboard.

If the problem is resolved, the keyboard must be replaced (see "[Getting Help](#)" for instructions on obtaining technical assistance).

4. Run the keyboard test in system diagnostics.

If you cannot use the keyboard to select the keyboard test, continue to step 5.

If the test did not run successfully, see "[Getting Help](#)" for instructions on obtaining technical assistance.

5. Swap the faulty keyboard with a working keyboard.

If the problem is resolved, the faulty keyboard must be replaced. If the problem is not resolved, the controller is faulty (see "[Getting Help](#)" for instructions on obtaining technical assistance).

## Troubleshooting the Mouse

### Problem

- 1 System error message indicates a mouse problem

### Action

1. Determine whether the system has monitors attached to both the front and rear video connectors.

The system supports only one monitor attached to either the front or rear video connector. When a monitor is connected to the front panel, the back-panel video, and PS/2 keyboard and mouse connectors are disabled.

If two monitors are attached to the system, disconnect one monitor. If the problem is not resolved, continue to step 2.

2. Determine the type of mouse used and to which panel the mouse is connected.

If a USB mouse is connected to a USB connector on either the front or back panel, go to step 4.

If a PS/2 mouse is not connected to the front-panel PS/2 connector, go to step 4.

If a PS/2 mouse is connected to the front-panel PS/2 connector, continue to step 3.

3. Ensure that the PS/2 mouse is connected to the front panel using a keyboard/mouse cable adapter.

The front-panel PS/2 connector supports a mouse only with a keyboard/mouse cable adapter.

If a PS/2 mouse is connected to the front-panel PS/2 connector, use a keyboard/mouse cable adapter or replace the PS/2 mouse with a USB mouse. If you do not have a keyboard/mouse cable adapter, see "[Getting Help](#)" for instructions on obtaining technical assistance.

4. Look at the mouse and the mouse cable for any signs of damage.

5. Click each button on the mouse.

If the mouse and its cable appear to be free of physical damage, and the buttons work, go to step 7.

If the mouse or its cable are damaged, continue to step 6.

6. Swap the faulty mouse with a working mouse.

If the problem is resolved, the mouse must be replaced (see "[Getting Help](#)" for instructions on obtaining technical assistance).

7. Run the pointing devices test in system diagnostics.

If the problem is resolved, the faulty mouse must be replaced. If the problem is not resolved, the controller is faulty (see "[Getting Help](#)" for instructions on obtaining technical assistance).

## Troubleshooting the Basic I/O Functions

### Problem

- 1 System error message indicates an I/O port problem
- 1 Device connected to the port is not working

### Action

1. Enter the System Setup program (see "Using the System Setup Program" in the *User's Guide* for instructions) and check the **Serial Port** settings.

If the ports are set to **Off**, go to step 3.

If the ports are not set to **Off**, continue to step 2.

2. Change the **Serial Port** settings to **Auto**, then reboot the system.
3. Check the settings in the System Setup program.

See "Using the System Setup Program" in the *User's Guide* for instructions. If the settings are correct, go to step 5.

4. Change the necessary settings in the System Setup program. If the port problem is confined to a particular application program, see the application program's documentation for specific port configuration requirements.
5. Reboot the system from the diagnostics diskette, and run the serial port test in the system diagnostics.

If the test did not run successfully, see "[Getting Help](#)" for instructions on obtaining technical assistance.

If the test runs successfully but the problem persists, see "[Troubleshooting a Serial I/O Device](#)."

## Troubleshooting a Serial I/O Device

### Problem

- 1 Device connected to the port is not working

### Action

1. Turn off the system and any peripheral devices connected to the serial ports.
2. Swap the interface cable with a known working cable.

If the problem is resolved, the interface cable must be replaced (see "[Getting Help](#)," for instructions on obtaining technical assistance).

3. Turn off power to the system and the serial device, and swap the device with a comparable device.
4. Turn on the system and the serial device.

If the problem is resolved, the serial device must be replaced. If the problem is not resolved, see "[Getting Help](#)" for instructions on obtaining technical assistance.

## Troubleshooting a USB Device

### Problem

- 1 System error message indicates problem
- 1 Device connected to the port is not working

### Action

1. Enter the System Setup program and ensure that the USB ports are enabled (see "Using the System Setup Program" in the *User's Guide* for instructions).
2. Turn off the system and any USB devices.

If there is only one USB device connected to the system, go to step 5.

3. Disconnect all USB devices, and connect the malfunctioning device to the other port.
4. Turn on the system and the reconnected device.

If the problem is resolved, the USB port may be defective (see "[Getting Help](#)" for instructions on obtaining technical assistance).

5. If possible, swap the interface cable with a known working cable.

If the problem is resolved, the interface cable must be replaced (see "[Getting Help](#)" for instructions on obtaining technical assistance).

6. Turn off the system and the USB device, and swap the device with a comparable device.
7. Turn on the system and the USB device.

If the problem is resolved, the USB device must be replaced. If the problem is not resolved, see "[Getting Help](#)" for instructions on obtaining technical assistance.

## Troubleshooting the NICs

### Problem

- 1 A NIC cannot communicate with the network

## Action

1. Check the appropriate indicator on the NIC connector (see [Figure 2-6](#)).

A green indicator shows that the adapter is connected to a valid link partner. A blinking amber indicator shows that network data is being sent or received.

- 1 If the link indicator is not on, check all cable connections.
- 1 Try changing the auto-negotiation setting, if possible.
- 1 Try another port on the switch or hub.

If you are using a NIC expansion card instead of the integrated NICs, see the documentation for the NIC card.

2. If the indicator does not light, the network driver files might be damaged or deleted. Check the drivers, and remove and reinstall the drivers if applicable.

You must reboot your system for the reinstalled drivers to become active.

3. Ensure that the appropriate drivers are installed and the protocols are bound.
4. Enter the System Setup program and confirm that the NICs are enabled (see "Using the System Setup Program" in the *User's Guide*).
5. Ensure that the NICs, hubs, and switches on the network are all set to the same data transmission speed.
6. Ensure that all network cables are of the proper type and do not exceed the specified length. For more information, see "Network Cable Requirements" in the *User's Guide*.

---

## Inside the System

In [Figure 5-4](#), the covers and bezel are removed to provide an interior view of the system.

**Figure 5-4. Inside the System**

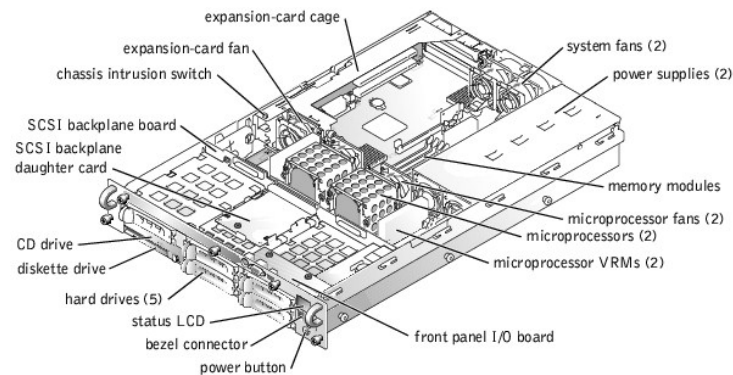

The system board holds the system's control circuitry and other electronic components. Several hardware options, such as the microprocessors and memory, are installed directly on the system board. The expansion-card cage accommodates up to three full-length PCI or PCI-X expansion cards.

The system provides space for a 3.5-inch diskette drive and a CD drive. The CD/diskette drive tray connects to the controllers on the system board through the SCSI backplane board. For more information, see "[Installing Drives](#)."

The hard-drive bays provide space for up to five 1-inch SCSI hard drives. The hard drives connect to a controller on the system board or a RAID controller card through the SCSI backplane board. For more information, see "[Installing Drives](#)."

During an installation or troubleshooting procedure, you may be required to change a jumper setting. For more information, see "[Jumpers and Connectors](#)."

---

## Responding to a Systems Management Alert Message

The optional systems management software monitors critical system voltages and temperatures, the system cooling fans, and the status of the SCSI hard drives in the system. Alert messages appear in the alert log window. For information about the alert log window and options, see the systems management software documentation.

---

## Troubleshooting a Wet System

### Problem

- 1 Liquid spills
- 1 Splashes
- 1 Excessive humidity

#### Action

1. Turn off the system, including any attached peripherals, and disconnect the system from the electrical outlet.
2. Remove the cover (see "[Removing the Cover](#)").
3. Remove all expansion cards installed in the system (see "[Removing an Expansion Card](#)" in "Installing System Options").
4. Let the system dry thoroughly for at least 24 hours.
5. Replace the cover (see "[Replacing the Cover](#)").
6. Reconnect your system and peripherals to their electrical outlets, and turn on the system.

If the system does not start up properly, see "[Getting Help](#)," for instructions on obtaining technical assistance.

7. If the system starts up normally, shut down the system and reinstall all expansion cards you removed in step 3 (see "[Installing an Expansion Card](#)" in "Installing System Options").
8. Run the system board tests in system diagnostics to confirm that the system is working properly.

If the tests did not complete successfully, see "[Getting Help](#)" for instructions on obtaining technical assistance.

---

## Troubleshooting a Damaged System

#### Problem

- 1 System dropped or damaged

#### Action

1. Ensure that the following components are properly installed:
  - 1 Expansion-card cage
  - 1 Expansion cards
  - 1 Power supplies
  - 1 Cooling fans
  - 1 System board tray
  - 1 Drive carrier connections to the SCSI backplane board
2. Ensure that all cables are properly connected.
3. Ensure that all components are properly installed and are free from damage.
4. Run the system board tests in system diagnostics.

If the tests did not complete successfully, see "[Getting Help](#)" for instructions on obtaining technical assistance.

---

## Troubleshooting the System Battery

#### Problem

- 1 Error message shows a problem with the battery
- 1 System Setup program loses system configuration information
- 1 System date and time do not stay current

The system battery maintains system configuration, date, and time information in a special section of memory when you turn off the system. The operating life of the battery ranges from 2 to 5 years, depending on how you use the system (for example, if you keep the system on most of the time, the battery gets little use and thus lasts longer). You may need to replace the battery if an incorrect time or date is displayed during the boot routine.

You can operate the system without a battery; however, the system configuration information maintained by the battery in NVRAM is erased each time you remove power from the system. Therefore, you must re-enter the system configuration information and reset the options each time the system boots until you replace the battery.

#### Action

1. Re-enter the time and date through the System Setup program (see "Using the System Setup Program" in the *User's Guide* for instructions).
2. Turn off and disconnect the system from the electrical outlet for at least one hour.
3. Reconnect the system to the electrical outlet and turn the system on again.



4. Enter the System Setup program.

If the date and time are not correct in the System Setup program, replace the battery (see "[Replacing the System Battery](#)" in "Installing System Options").

If the problem is not resolved by replacing the battery, see "[Getting Help](#)" for instructions on obtaining technical assistance.

- NOTE: Some software may cause the system time to speed up or slow down. If the system seems to operate normally except for the time kept in the System Setup program, the problem may be caused by software rather than by a defective battery.
  - NOTE: If the system is turned off for long periods of time (for weeks or months), the NVRAM may lose its system configuration information. This situation is caused by a defective battery.
- 

## Troubleshooting Power Supplies

### Problem

- 1 System-status indicators are amber
- 1 Front-panel status LCD indicating a problem with power supply
- 1 Power-supply fault indicator signifies a problem

### Action

1. Locate the faulty power supply.

The power supply's fault indicator is lit (see [Figure 2-4](#)).

- NOTICE: The power supplies are hot-pluggable. The system requires one power supply to be installed for the system to operate normally. The system is in the redundant mode when two power supplies are installed. Remove and replace only one power supply at a time in a system that is powered on.

2. Remove the faulty power supply (see "[Removing a Power Supply](#)" in "Installing System Options").
3. Install the new power supply (see "[Replacing a Power Supply](#)" in "Installing System Options").

- NOTE: After installing a new power supply, allow several seconds for the system to recognize the power supply and determine whether it is working properly. The power-on indicator will turn green to signify that the power supply is functioning properly (see [Figure 2-4](#)).

4. If the problem is not resolved, install a new power supply (see "[Replacing a Power Supply](#)" in "Installing System Options").
  5. If the problem is not resolved, see "[Getting Help](#)," for information on obtaining technical assistance.
- 

## Troubleshooting System Cooling

### Problem

- 1 Systems management software issues a fan-related error message
- 1 Front-panel status LCD indicating a problem with cooling

### Action

Cooling of the entire system or individual components inside the system can be affected by the following conditions:

- 1 Ambient temperature surrounding the system is too high
- 1 Airflow intake and output for the system is obstructed
- 1 Cables inside the system obstruct cooling fan intake or output
- 1 Expansion-card filler brackets are not installed over empty expansion slots
- 1 An individual cooling fan has failed (see "[Troubleshooting a Cooling Fan](#)")

To maintain proper cooling while the system is on, ensure that none of the conditions listed above exists. If an individual cooling fan has failed, see "[Troubleshooting a Cooling Fan](#)" to resolve the problem.

## Troubleshooting a Cooling Fan

### Problem

- 1 System-status indicators are amber
- 1 Front-panel status LCD indicating a problem with cooling
- 1 Fan status indicator signifies a problem with the fan
- 1 Systems management software issues a fan-related error message

### Action

 **NOTICE:** The cooling fans are hot-pluggable. To maintain proper cooling while the system is on, replace only one fan at a time.

1. Remove the cover (see "[Removing the Cover](#)").
2. Locate the faulty fan.

The fan's indicator is amber blinking (see [Figure 2-7](#)).

3. Remove the faulty fan (see "[Removing a Cooling Fan](#)" in "Installing System Options").
4. Reseat the fan and ensure that the fan connector is firmly seated.

 **NOTE:** After installing a new fan, allow up to 30 seconds for the system to recognize the fan and determine whether it is working properly. The fan status indicator on the system board will turn green to signify that the fan is functioning properly (see [Figure 2-7](#)).

5. If the problem is not resolved, install a new fan (see "[Replacing a Cooling Fan](#)" in "Installing System Options").
  6. If the replacement fan does not operate, the fan connector is faulty (see "[Getting Help](#)," for information on obtaining technical assistance).
- 

## Troubleshooting a Microprocessor

### Problem

- 1 Error message indicating a microprocessor problem
- 1 Front-panel status LCD indicating a problem with microprocessors, VRMs, or the system board
- 1 A heat sink is not installed for each microprocessor

### Action

1. Observe the precautions in "[Safety First—For You and Your System](#)."
2. Turn off the system, including any attached peripherals, and disconnect the system from its electrical outlet.

 **NOTICE:** See "Protecting Against Electrostatic Discharge" in the safety instructions in your *System Information* document.

3. Remove the cover (see "[Removing the Cover](#)").
  4. Ensure that VRMs are properly installed for each microprocessor (see [Figure 6-9](#)).
  5. Replace the cover (see "[Replacing the Cover](#)").
  6. Reconnect the system to its electrical outlet and turn the system on, including any attached peripherals.
  7. Run **Quick Tests** in the system diagnostics.
- If the problem persists, continue to step 8.
8. Turn off the system, including any attached peripherals, and disconnect the system from its electrical outlet.
  9. Remove the cover (see "[Removing the Cover](#)").
  10. Remove microprocessor 2 and VRM 2, leaving microprocessor 1 and VRM 1 installed (see "[Adding or Replacing a Microprocessor](#)" in "Installing System Options"). To locate microprocessor 1 and VRM 1, see [Figure A-3](#).

If there is only one microprocessor installed, see "[Getting Help](#)."

11. Replace the cover (see "[Replacing the Cover](#)").
  12. Reconnect the system to its electrical outlet and turn the system on, including any attached peripherals.
  13. Run **Quick Tests** in the system diagnostics.
- If the tests complete successfully, continue to step 14.
14. Turn off the system, including any attached peripherals, and disconnect the system from its electrical outlet.
  15. Remove the cover (see "[Removing the Cover](#)").
  16. Reinstall microprocessor 2 and VRM 2 you removed in step 10 (see "[Adding or Replacing a Microprocessor](#)" in "Installing System Options").
  17. Run **Quick Tests** in the system diagnostics.

If the problem persists, see "[Getting Help](#)."

---

## Troubleshooting Expansion Cards

### Problem

- 1 Error message indicates an expansion-card problem
- 1 Expansion card seems to perform incorrectly or not at all
- 1 Front-panel status LCD indicating a problem with expansion cards or the system board
- 1 Expansion-card filler brackets are not installed over empty expansion slots

#### Action

➔ **NOTICE:** When troubleshooting an expansion card, see the documentation for your operating system and the expansion card.

1. Observe the precautions in "[Safety First—For You and Your System](#)."
2. Turn off the system, including any attached peripherals, and disconnect the system from its electrical outlet.

➔ **NOTICE:** See "Protecting Against Electrostatic Discharge" in the safety instructions in your *System Information* document.

3. Remove the cover (see "[Removing the Cover](#)").
4. Ensure that the expansion-card cage is properly installed (see "[Replacing the Expansion-Card Cage](#)" in "Installing System Options").
5. Ensure that each expansion card is firmly seated in its connector (see "[Installing an Expansion Card](#)" in "Installing System Options").
6. Ensure that any appropriate cables are firmly connected to their corresponding connectors on the expansion cards.
7. Replace the cover (see "[Replacing the Cover](#)").
8. Reconnect the system to its electrical outlet and turn the system on, including any attached peripherals.
9. Run **Quick Tests** in the system diagnostics.

If the problem persists, go to step 10.

10. Turn off the system, including any attached peripherals, and disconnect the system from its electrical outlet.
11. Remove the cover (see "[Removing the Cover](#)").
12. Remove all expansion cards installed in the system (see "[Removing an Expansion Card](#)" in "Installing System Options").
13. Replace the cover (see "[Replacing the Cover](#)").
14. Reconnect the system to its electrical outlet and turn the system on, including any attached peripherals.
15. Run **Quick Tests** in the system diagnostics.

If the tests do not complete successfully, see "[Getting Help](#)" for information on obtaining technical assistance.

16. For each of the remaining expansion cards, perform the following steps:
  - a. Turn off the system, including any attached peripherals, and disconnect the system from its electrical outlet.
  - b. Remove the cover (see "[Removing the Cover](#)").
  - c. Reinstall one of the expansion cards you removed in step 12.
  - d. Run **Quick Tests** in the system diagnostics.

If the tests do not complete successfully, see "[Getting Help](#)" for information on obtaining technical assistance. If you have reinstalled all of the expansion cards and the **Quick Tests** are still failing, see "[Getting Help](#)" for information on obtaining technical assistance.

---

## Troubleshooting System Memory

#### Problem

- 1 Faulty memory module
- 1 Faulty system board
- 1 Front-panel status LCD indicating a problem with system memory

#### Action

1. Turn on the system, including any attached peripherals.

If no error messages appear, go to step 15.

2. Enter the System Setup program to check the system memory setting (see "Using the System Setup Program," in the *User's Guide* for instructions).
3. If the amount of memory matches the system memory setting, go to step 15. Otherwise, continue to step 4.
4. Turn off the system, including any attached peripherals, and disconnect the system from its electrical outlet.
5. Remove the cover (see "[Removing the Cover](#)").

➔ **NOTICE:** See "Protecting Against Electrostatic Discharge" in the safety instructions in your *System Information* document.

6. Reseat the memory modules in their connectors (see "[Installing Memory Modules](#)" in "Installing System Options").
7. Replace the cover (see "[Replacing the Cover](#)").
8. Reconnect the system to its electrical outlet and turn the system on, including any attached peripherals.
9. Enter the System Setup program and check the system memory again.

If the amount of memory installed does not match the system memory setting, perform the following steps:

- a. Turn off the system, including any attached peripherals, and disconnect the system from its electrical outlet.
- b. Remove the cover (see "[Removing the Cover](#)").

 **NOTE:** There are multiple configurations for the memory modules; see "[Memory Module Installation Guidelines](#)" in "Installing System Options." The following steps are an example of one configuration.

10. Swap the memory module pair in bank 1 with another pair of the same capacity.
11. Replace the cover (see "[Replacing the Cover](#)").
12. Reconnect your system and peripherals to their electrical outlets, and turn on the system.
13. As the system boots, observe the monitor screen and the indicators on the keyboard.
14. Perform the following steps:
  - a. Turn off the system, including any attached peripherals, and disconnect the system from its electrical outlet.
  - b. Remove the cover (see "[Removing the Cover](#)").
  - c. Repeat steps 10 through 13 for each memory module pair installed.

If the problem is not resolved, see "[Getting Help](#)."

15. Run the system memory test in system diagnostics.

If the test does not complete successfully, see "[Getting Help](#)."

---

## Troubleshooting the Diskette Drive

### Problem

1. Error message indicates a diskette drive problem

### Action

1. Enter the System Setup program and verify that the system is configured correctly (see "Using the System Setup Program" in the *User's Guide*).
2. Remove the bezel (see "[Removing the Bezel](#)").
3. Run the diskette drive tests from the diagnostics diskette to see whether the diskette drive works correctly.

If the tests failed, continue to step 4.

4. Turn off the system, including any attached peripherals, and disconnect the system from its electrical outlet.
5. Ensure that the CD/diskette drive tray is properly installed (see "[Installing the CD/Diskette Drive Tray](#)" in "Installing Drives").
6. Connect the system to its electrical outlet and turn on the system, including any attached peripherals.
7. Replace the bezel (see "[Replacing the Bezel](#)").
8. Run the diskette drive tests from the diagnostics diskette to see whether the diskette drive works correctly.

If the tests failed, continue to step 9.

9. Turn off the system, including any attached peripherals, and disconnect the system from its electrical outlet.
10. Remove the cover (see "[Removing the Cover](#)").
11. Ensure that the system board tray is properly installed (see "[Replacing the System Board Tray](#)" in "Installing System Options").
12. Replace the back cover (see "[Replacing the Cover](#)").
13. Reconnect the system to its electrical outlet and turn the system on, including any attached peripherals.
14. Run the diskette drive tests from the diagnostics diskette to see whether the diskette drive works correctly.

If the problem persists, continue to step 15.

15. Turn off the system, including any attached peripherals, and disconnect the system from its electrical outlet.
16. Remove the cover (see "[Removing the Cover](#)").
17. Remove all expansion cards installed in the system (see "[Removing an Expansion Card](#)" in "Installing System Options").
18. Replace the cover (see "[Replacing the Cover](#)").

19. Reconnect the system to its electrical outlet and turn the system on, including any attached peripherals.
20. Run the diskette drive tests from the diagnostics diskette to see whether the diskette drive works correctly.

If the test ran successfully, an expansion card may be conflicting with the diskette drive logic, or you may have a faulty expansion card. Continue to step 21.

If the test failed, see "[Getting Help](#)" for instructions on obtaining technical assistance.

21. Turn off the system, including any attached peripherals, and disconnect the system from its electrical outlet.
22. Remove the cover (see "[Removing the Cover](#)").
23. Reinstall one of the expansion cards you removed in step 17 (see "[Installing an Expansion Card](#)" in "Installing System Options").
24. Replace the cover (see "[Replacing the Cover](#)").
25. Reconnect the system to its electrical outlet and turn the system on, including any attached peripherals.
26. Run the diskette drive tests from the diagnostics diskette to see whether the diskette drive works correctly.
27. Repeat steps 21 through 26 until all expansion cards have been reinstalled or until one of the expansion cards prevents the system from booting from the diagnostics diskette.

If the problem is not resolved, see "[Getting Help](#)" for instructions on obtaining technical assistance.

---

## Troubleshooting a CD Drive

### Problem

- 1 System cannot read data from a CD
- 1 CD drive indicator fails to blink during boot

### Action

1. Enter the System Setup program to ensure that the IDE device is enabled (see "Using the System Setup Program," in the *User's Guide*).
2. Run the IDE devices tests in the system diagnostics to determine whether the CD drive works correctly.

If the tests failed, continue to step 3.

3. Remove the bezel (see "[Removing the Bezel](#)").
4. Turn off the system, including any attached peripherals, and disconnect the system from its electrical outlet.
5. Ensure that the CD/diskette drive tray is properly installed (see "[Installing the CD/Diskette Drive Tray](#)" in "Installing Drives").
6. Reconnect the system to an electrical outlet and turn on the system, including any attached peripherals.
7. Replace the bezel (see "[Replacing the Bezel](#)").

If the problem persists, continue to step 8.

8. Run the IDE devices tests in the system diagnostics to determine whether the CD drive works correctly.

If the tests failed, continue to step 9.

9. Turn off the system, including any attached peripherals, and disconnect the system from its electrical outlet.
10. Remove the cover (see "[Removing the Cover](#)").
11. Ensure that the system board tray is properly installed (see "[Replacing the System Board Tray](#)" in "Installing System Options").
12. Replace the back cover (see "[Replacing the Cover](#)").
13. Reconnect the system to its electrical outlet and turn the system on, including any attached peripherals.
14. Run the IDE devices tests in the system diagnostics to determine whether the CD drive works correctly.

If the problem is not resolved, see "[Getting Help](#)" for instructions on obtaining technical assistance.

---

## Troubleshooting an External SCSI Tape Drive

### Problem

- 1 Defective tape drive
- 1 Defective tape cartridge
- 1 Software or device driver
- 1 Defective SCSI host adapter

### Action

1. Remove the tape that was in use when the problem occurred and replace it with a tape that you know is not defective.
2. Verify that any required SCSI device drivers are installed on the hard drive and are configured correctly.

For information on device drivers for the system's integrated SCSI controller, see "Installing and Configuring SCSI Drivers" in the *User's Guide*.

3. Reinstall the tape-backup software as instructed in the tape-backup software documentation.
  4. Check the cable connections to the drive.
    - a. Turn off the system, including any attached peripherals, and disconnect the system from its electrical outlet.
    - b. Check the SCSI cable connection from the tape drive to the SCSI controller card installed in the system.
    - c. Check the AC power cable connection to the tape drive.
  5. Verify that the tape drive is configured for a unique SCSI ID number and that the tape drive is terminated or not terminated as appropriate.
  6. See the documentation for the tape drive for instructions on selecting the SCSI ID and enabling or disabling termination.
  7. Reconnect the system to the electrical outlet and turn on the system.
  8. If the problem is not resolved, see "[Getting Help](#)" for instructions on obtaining technical assistance.
- 

## Troubleshooting Hard Drives

### Problem

- 1 Faulty hard drive
- 1 Faulty SCSI backplane board
- 1 Faulty or loose SCSI cable connections
- 1 Hard-drive status indicator signifies a problem with the drive
- 1 Front-panel status LCD indicating a problem with hard drives

### Action

 **NOTICE:** This troubleshooting procedure can destroy data stored on the hard drive. Before you continue, back up all the files on the hard drive.

1. Reboot your system and enter the SCSI configuration utility by pressing <Ctrl><h>, <Ctrl><a>, or <Ctrl><m>, depending on your SCSI or RAID controller.
2. Ensure that the primary SCSI channel is enabled, and reboot the system.

See the documentation supplied with the controller for information on the configuration utility.

3. Verify that the device drivers are installed and configured correctly (see the operating system's documentation).

 **NOTE:** If a drive shows signs of imminent failure, the status indicator blinks green, then amber, and then off, repeating this sequence every two seconds. If a drive has failed, the status indicator blinks amber four times per second.

4. Remove the hard drive and install it in the another drive bay.
5. If the problem is resolved, reinstall the hard drive in the original bay.

If the hard drive functions properly in the original bay, the drive carrier could have intermittent problems. Ensure that the drive is properly mounted on the drive carrier (see "[Installing a SCSI Hard Drive](#)" in "Installing Drives").

If the drive carrier still does not function properly in the original bay, the SCSI backplane board has a defective connector. See "[Getting Help](#)" for instructions on obtaining technical assistance.

6. If a RAID controller card is installed, check the SCSI cable connections inside the system:
  - a. Turn off the system, including any attached peripherals, and disconnect the system from its electrical outlet.
  - b. Remove the cover (see "[Removing the Cover](#)").
  - c. Check the SCSI cable connection to the RAID controller card (see the RAID controller's documentation for detailed information).

 **NOTE:** To operate the SCSI backplane in a 1 x 5 configuration, ensure that the SCSI backplane daughter card is not installed. To operate the SCSI backplane in a 2/3 split configuration, ensure that the SCSI backplane daughter card is installed (see "[Installing a SCSI Backplane Daughter Card](#)" in "Installing Drives").

- d. Replace the back cover (see "[Replacing the Cover](#)").
  - e. Reconnect the system to its electrical outlet and turn the system on, including any attached peripherals.
7. Partition and logically format the hard drive. If possible, restore the files to the drive.

To partition and logically format the drive, see the operating system documentation.

If the problem is not resolved, see "[Getting Help](#)" for instructions on obtaining technical assistance.

---

## Troubleshooting the Integrated RAID Controller

### Problem

1. Error message indicates integrated RAID controller problem

### Action

1. Enter the System Setup program and check the setting for the integrated RAID controller (see "Using the System Setup Program" in the *User's Guide*).

If the controller is enabled, go to step 4.

2. Change the RAID controller setting to **Enabled**, and then reboot the system.
3. See the documentation provided with the RAID controller software and check the software settings.
4. Turn off the system, including any attached peripherals, and disconnect the system from its electrical outlet.

 **NOTICE:** See "Protecting Against Electrostatic Discharge" in the safety instructions in your *System Information* document.

5. Remove the cover (see "[Removing the Cover](#)").
6. Reseat the RAID memory module in its connector (see [Figure 7-3](#) in "Installing Drives").
7. Reseat the RAID hardware key in its connector (see [Figure 7-4](#) in "Installing Drives").
8. Reseat the RAID battery cable connector (see [Figure 7-5](#) in "Installing Drives").
9. Replace the back cover (see "[Replacing the Cover](#)").
10. Reconnect the system to its electrical outlet and turn the system on, including any attached peripherals.

If the problem is not resolved, continue to step 11.

11. Turn off the system, including any attached peripherals, and disconnect the system from its electrical outlet.
12. Remove the cover (see "[Removing the Cover](#)").

 **CAUTION:** Replace the battery only with the same or equivalent type recommended by the manufacturer. Discard used batteries according to the manufacturer's instructions. See the *System Information* document for additional information.

13. Replace the RAID battery (see [Figure 7-5](#) in "Installing Drives").
14. Replace the back cover (see "[Replacing the Cover](#)").
15. Reconnect the system to its electrical outlet and turn the system on, including any attached peripherals.

If the problem is not resolved, see "[Getting Help](#)" for instructions on obtaining technical assistance.

---

## Troubleshooting a RAID Controller Card

Your system may contain an optional RAID controller card. If you encounter problems with the controller, see the RAID controller's documentation for detailed information on troubleshooting.

---

[Back to Contents Page](#)

[Back to Contents Page](#)

## Installing System Options

Dell™ PowerEdge™ 2650 Systems Installation and Troubleshooting Guide

- [System Fans](#)
- [Power Supplies](#)
- [Expansion-Card Cage](#)
- [Expansion Cards](#)
- [Memory Modules](#)
- [System Board Tray](#)
- [Microprocessors](#)
- [System Battery](#)

This section describes how to remove and replace the following components:

- 1 Expansion cards
- 1 Memory upgrades
- 1 Microprocessor upgrades

This section also includes instructions for replacing the fans, power supplies, and system battery, if necessary.

---

### System Fans

The system includes the following hot-pluggable cooling fans:

- 1 Two system fans
- 1 One expansion-card fan
- 1 One microprocessor fan for each installed microprocessor

The system may also include other optional hot-pluggable fans.

### Removing a Cooling Fan

- 📌 **NOTE:** The procedure for removing each individual fan is the same.
- 👉 **NOTICE:** See "Protecting Against Electrostatic Discharge" in the safety instructions in your *System Information* document.
- 👉 **NOTICE:** The cooling fans are hot-pluggable. To maintain proper cooling while the system is on, replace only one fan at a time.

1. Remove the cover (see "[Removing the Cover](#)" in "Troubleshooting Your System").
2. Pull the fan straight up to clear the chassis (see [Figure 6-1](#)).

Figure 6-1. Removing and Installing a Cooling Fan

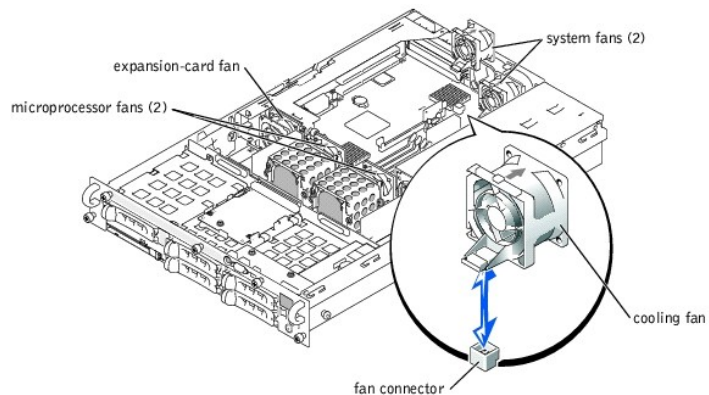

### Replacing a Cooling Fan

- 📌 **NOTE:** The procedure for installing each individual fan is the same.



1. Lower the fan into the retention base until the fan snaps into position (see [Figure 6-1](#)).
2. Replace the cover (see "[Replacing the Cover](#)" in "Troubleshooting Your System").

---

## Power Supplies

The system includes one or two hot-pluggable power supplies.

### Removing a Power Supply

**NOTICE:** The power supplies are hot-pluggable. The system requires one power supply to be installed for the system to operate normally. The system is in the redundant mode when two power supplies are installed. Remove and replace only one power supply at a time in a system that is powered on.

1. Squeeze the latch at the bottom of the power-supply handle.
2. Rotate the power-supply handle up until the power supply is released from the chassis (see [Figure 6-2](#)).
3. Pull the power supply straight out to clear the chassis (see [Figure 6-2](#)).

Figure 6-2. Removing and Installing a Power Supply

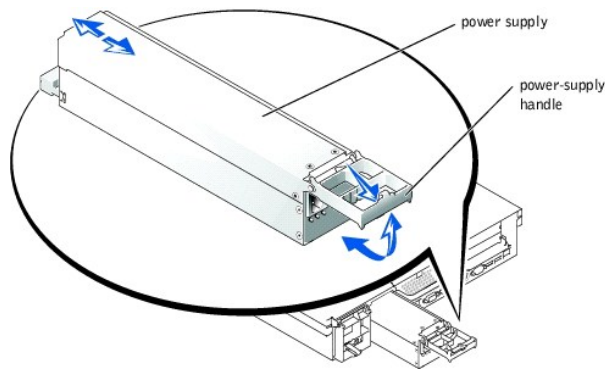

### Replacing a Power Supply

1. With the power-supply handle in the extended position, slide the new power supply into the chassis (see [Figure 6-2](#)).
2. Rotate the handle down until it snaps into place (see [Figure 6-2](#)).

**NOTE:** After installing a new power supply, allow several seconds for the system to recognize the power supply and determine whether it is working properly. The power-on indicator will turn green to signify that the power supply is functioning properly (see [Figure 2-4](#)).

---

## Expansion-Card Cage

The removable expansion-card cage simplifies many installation procedures by allowing you to remove the riser board and all installed expansion cards in a single step.

### Removing the Expansion-Card Cage

**CAUTION:** Before you perform this procedure, you must turn off the system and disconnect it from its power source. For more information, see "[Safety First—For You and Your System](#)" in "Troubleshooting Your System."

**NOTICE:** See "Protecting Against Electrostatic Discharge" in the safety instructions in your *System Information* document.

1. Turn off the system, including any attached peripherals, and disconnect the system from the electrical outlet.
2. Remove the cover (see "[Removing the Cover](#)" in "Troubleshooting Your System").
3. Disconnect all expansion-card cables.
4. Rotate the expansion-card cage lever up until the cage is released from the chassis (see [Figure 6-3](#)).
5. Lift the cage straight up to clear the chassis (see [Figure 6-3](#)).

Figure 6-3. Removing and Installing the Expansion-Card Cage

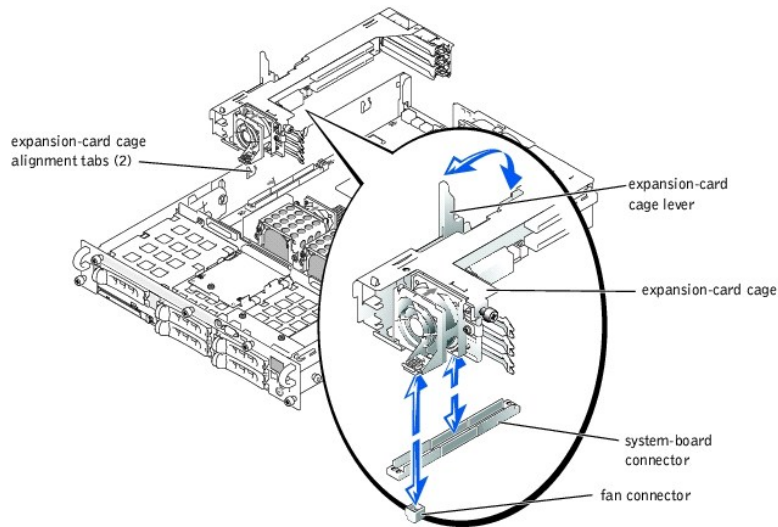

## Replacing the Expansion-Card Cage

➡ **NOTICE:** See "Protecting Against Electrostatic Discharge" in the safety instructions in your *System Information* document.

1. With the expansion-card cage lever in the upright position, lower the cage into the chassis until it is aligned with the tabs on the chassis side wall (see [Figure 6-3](#)).
2. Rotate the expansion-card cage lever down until the handle is flush with the top of the cage, and the cage is secured in the chassis (see [Figure 6-3](#)).
3. Reconnect all expansion-card cables.
4. Replace the cover (see "[Replacing the Cover](#)" in "Troubleshooting Your System").

## Expansion Cards

The system includes three expansion slots. The expansion cards are installed on the system's riser board (see [Figure A-4](#) to identify the expansion slots).

### Expansion Card Installation Guidelines

You can install expansion cards of different operating speeds on the same bus; however, the bus will operate at the slowest operating speed of the cards on that bus. For example, if one card on the bus has an operating speed of 66 MHz and the other card has an operating speed of 100 MHz, the bus will only operate at 66 MHz.

To identify expansion slots and PCI buses, see [Figure A-4](#). [Table 6-1](#) lists the PCI bus and operating speed for each expansion-card slot.

**Table 6-1. Expansion Slot Speeds**

Slot	Bus	Operating Speed
1	1	33, 66, or 100 MHz
2	1	<ul style="list-style-type: none"> <li>┆ Slot 1 is not empty — 33, 66, or 100 MHz</li> <li>┆ Slot 1 is empty — 33, 66, 100, or 133 MHz</li> </ul>
3	2	33, 66, 100, or 133 MHz

**NOTE:** If you are using expansion cards of different operating speeds, you should install the fastest card in slot 3 and the slowest card in slot 1.

### PCI Bus Scan Order

The system's BIOS scans and numbers PCI buses and devices during startup. Expansion slots are scanned according to the host bus ordering, not by the slot numbers. See [Table 6-2](#) for the order in which the expansion slots and embedded PCI devices are scanned. [Figure A-4](#) provides a diagram of buses and expansion slots.

An additional factor affects the assignment of PCI bus numbers: an expansion card may have its own PCI bridge chip which requires the assignment of a bus number for the card as well as one for the bridge. A particular expansion card may have two PCI bridge chips which would result in three sequential PCI bus numbers all assigned in the same expansion slot.

If you install expansion cards, you may have some difficulty in directly determining the bus number of a controller on a particular expansion card. However, the PCI bus scan order listed in [Table 6-2](#) can help determine the relative numbering of PCI buses within the expansion slots. For example, a PCI controller residing in expansion slot 3 will never have a lower bus number than one in slot 2 because slot 2 precedes slot 3 in the scan order.

Table 6-2. PCI Bus Scan Order

Order	Device or Slot
1	Video
2	Embedded remote access components
3	Expansion slot 1
4	Expansion slot 2
5	Expansion slot 3
6	Integrated NIC 1
7	Integrated NIC 2
8	Integrated SCSI controller on the system board
9	Optional integrated RAID controller on the system board

**NOTE:** For the full name of an abbreviation or acronym used in this table, see "[Abbreviations and Acronyms](#)."

## Installing an Expansion Card

 **CAUTION:** Before you perform this procedure, you must turn off the system and disconnect it from its power source. For more information, see "[Safety First—For You and Your System](#)" in "Troubleshooting Your System."

 **NOTICE:** See "Protecting Against Electrostatic Discharge" in the safety instructions in your *System Information* document.

1. Unpack the expansion card, and prepare it for installation.

For instructions, see the documentation accompanying the card.

2. Turn off the system, including any attached peripherals, and disconnect the system from the electrical outlet.
3. Remove the cover (see "[Removing the Cover](#)" in "Troubleshooting Your System").
4. Disconnect all expansion-card cables.
5. Remove the expansion-card cage (see "[Removing the Expansion-Card Cage](#)").
6. Position the expansion-card cage so that the riser board lies horizontally on your work surface.
7. Open the expansion-card latch (see [Figure 6-4](#)) and remove the filler bracket.
8. Install the expansion card (see [Figure 6-4](#)).
  - a. Position the expansion card so that the card-edge connector aligns with the expansion-card connector on the expansion-card riser board.
  - b. Insert the card-edge connector firmly into the expansion-card connector until the card is fully seated.
  - c. When the card is seated in the connector, close the expansion-card latch (see [Figure 6-4](#)).

The card guide latch closes automatically as the card is seated in the connector.

Figure 6-4. Installing an Expansion Card

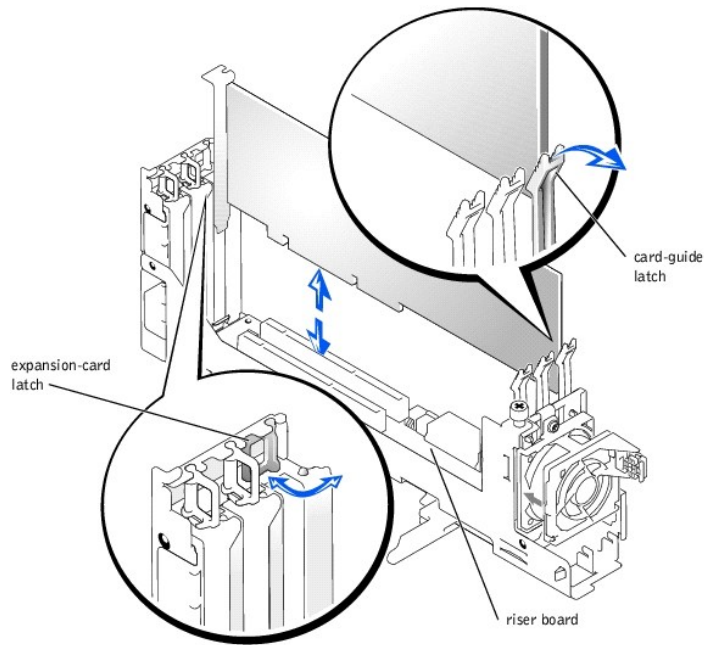

9. Replace the expansion-card cage (see ["Replacing the Expansion-Card Cage"](#)).
10. Reconnect all expansion-card cables, including those for the new card.

See the documentation that came with the card for information about its cable connections.

**NOTE:** If the expansion card you are installing is of a different operating speed as the card already installed on the same PCI bus, all expansion cards on that bus will operate at the slower speed.

11. Replace the cover (see ["Replacing the Cover"](#) in "Troubleshooting Your System").

## Removing an Expansion Card

**CAUTION:** Before you perform this procedure, you must turn off the system and disconnect it from its power source. For more information, see ["Safety First—For You and Your System"](#) in "Troubleshooting Your System."

**NOTICE:** See "Protecting Against Electrostatic Discharge" in the safety instructions in your *System Information* document.

1. Turn off the system, including any attached peripherals, and disconnect the system from the electrical outlet.
2. Remove the cover (see ["Removing the Cover"](#) in "Troubleshooting Your System").
3. Disconnect all expansion-card cables.
4. Remove the expansion-card cage (see ["Removing the Expansion-Card Cage"](#)).
5. Position the expansion-card cage so that the riser board lies horizontally on your work surface.
6. Release the expansion card:
  - a. Open the expansion-card latch (see [Figure 6-4](#)).
  - b. Press the release tab on the card-guide latch (see [Figure 6-4](#)).
  - c. Grasp the expansion card by its top corners, and carefully remove it from the expansion-card connector.
7. If you are removing the card permanently, install a metal filler bracket over the empty expansion slot opening and close the expansion-card latch.

**NOTE:** You must install a filler bracket over an empty expansion slot to maintain Federal Communications Commission (FCC) certification of the system. The brackets also keep dust and dirt out of the system and aid in proper cooling and airflow inside the system.

8. Replace the expansion-card cage (see ["Replacing the Expansion-Card Cage"](#)).
9. Reconnect all expansion-card cables.
10. Replace the cover (see ["Replacing the Cover"](#) in "Troubleshooting Your System").

---

## Memory Modules

The six memory module connectors on the system board can accommodate 256 MB to 6 GB of registered memory modules. The memory module connectors are arranged in pairs which consist of three banks (DIMM A – DIMM C).

## Memory Upgrade Kits

The system is upgradable to 6 GB by installing combinations of 128-, 256-, 512-MB, and 1-GB registered DDR SDRAM modules. You can purchase memory upgrade kits as needed.

 **NOTE:** The memory modules must be PC-1600 compliant.

## Memory Module Installation Guidelines

Starting with the connector nearest the power supplies, the memory module connectors are labeled "DIMM A1" through "DIMM C2" (see [Figure A-3](#)). When you install memory modules, follow these guidelines:

- 1 You must install memory modules in matched pairs.
- 1 Install a pair of memory modules in connector DIMM A1 and A2 before installing a second pair in connectors B1 and B2, and so on.

[Table 6-3](#) lists several sample memory configurations based on these guidelines.

**Table 6-3. Sample Memory Module Configurations**

Total Desired Memory	DIMM A		DIMM B		DIMM C	
	1	2	1	2	1	2
256 MB	128 MB	128 MB	None	None	None	None
512 MB	256 MB	256 MB	None	None	None	None
1 GB	512 MB	512 MB	None	None	None	None
2 GB	512 MB	512 MB	512 MB	512 MB	None	None
2 GB	1 GB	1 GB	None	None	None	None
3 GB	1 GB	1 GB	512 MB	512 MB	None	None
6 GB	1 GB	1 GB	1 GB	1 GB	1 GB	1 GB

## Performing a Memory Upgrade

 **CAUTION:** Before you perform this procedure, you must turn off the system and disconnect it from its power source. For more information, see "[Safety First—For You and Your System](#)" in "Troubleshooting Your System."

 **NOTICE:** See "Protecting Against Electrostatic Discharge" in the safety instructions in your *System Information* document.

1. Turn off the system, including any attached peripherals, and disconnect the system from the electrical outlet.
2. Remove the cover (see "[Removing the Cover](#)" in "Troubleshooting Your System").
3. Install or replace the memory module pairs as necessary to reach the desired memory total (see "[Installing Memory Modules](#)" and "[Removing Memory Modules](#)").

See [Figure A-3](#) to locate the memory module connectors.

4. Replace the cover (see "[Replacing the Cover](#)" in "Troubleshooting Your System").
5. Reconnect the system to its electrical outlet and turn the system on, including any attached peripherals.

After the system completes the POST routine, it runs a memory test.

The system detects that the new memory does not match the system configuration information, which is stored in NVRAM. The monitor displays an error message that ends with the following words:

```
Press <F1> to continue; <F2> to enter System Setup
```

6. Press <F2> to enter the System Setup program, and check the **System Memory** setting.

The system should have already changed the value in the **System Memory** setting to reflect the newly installed memory.

7. If the **System Memory** value is incorrect, one or more of the memory modules may not be installed properly. Repeat steps 1 through 6, ensuring that the memory modules are firmly seated in their connectors.
8. Run the system memory test in system diagnostics.

## Installing Memory Modules

 **CAUTION:** Before you perform this procedure, you must turn off the system and disconnect it from its power source. For more information, see "[Safety First—For You and Your System](#)" in "Troubleshooting Your System."

 **NOTICE:** See "Protecting Against Electrostatic Discharge" in the safety instructions in your *System Information* document.

1. Turn off the system, including any attached peripherals, and disconnect the system from the electrical outlet.

2. Remove the cover (see "[Removing the Cover](#)" in "Troubleshooting Your System").
3. Locate the memory module connectors in which you will install a memory module (see [Figure A-3](#)).
4. Press down and outward on the memory module connector ejectors, as shown in [Figure 6-5](#), to allow the memory module to be inserted into the connector.

**Figure 6-5. Removing and Installing a Memory Module**

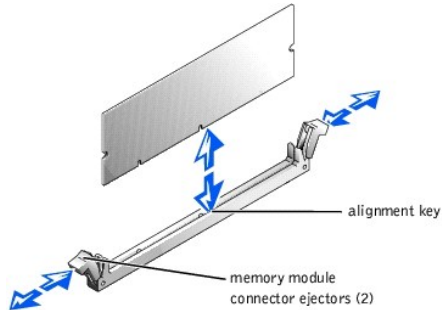

5. Align the memory module's edge connector with the alignment key, and insert the memory module in the connector (see [Figure 6-5](#)).  
The memory module connector has an alignment key that allows the memory module to be installed in the connector in only one way.
6. Press down on the memory module with your thumbs while pulling up on the ejectors with your index fingers to lock the memory module into the connector (see [Figure 6-5](#)).  
When the memory module is properly seated in the connector, the memory module connector ejectors should align with the ejectors on the other connectors with memory modules installed.
7. Repeat steps 3 through 6 of this procedure to install the remaining memory modules.
8. Perform steps 4 through 8 of the procedure in "[Performing a Memory Upgrade](#)."

## Removing Memory Modules

**CAUTION:** Before you perform this procedure, you must turn off the system and disconnect it from its power source. For more information, see "[Safety First—For You and Your System](#)" in "Troubleshooting Your System."

**NOTICE:** See "Protecting Against Electrostatic Discharge" in the safety instructions in your *System Information* document.

1. Turn off the system, including any attached peripherals, and disconnect the system from the electrical outlet.
2. Remove the cover (see "[Removing the Cover](#)" in "Troubleshooting Your System").
3. Locate the memory module connectors from which you will remove memory modules (see [Figure A-3](#)).
4. Press down and outward on the memory module connector ejectors until the memory module pops out of the connector (see [Figure 6-5](#)).
5. Repeat steps 3 and 4 of this procedure to remove any other memory modules.
6. Perform steps 4 through 8 of the procedure in "[Performing a Memory Upgrade](#)."

## System Board Tray

See [Figure A-3](#) to identify the system board components.

### Removing the System Board Tray

**CAUTION:** Before you perform this procedure, you must turn off the system and disconnect it from its power source. For more information, see "[Safety First—For You and Your System](#)" in "Troubleshooting Your System."

**NOTICE:** See "Protecting Against Electrostatic Discharge" in the safety instructions in your *System Information* document.

1. Turn off the system, including any attached peripherals, and disconnect the system from the electrical outlet.
2. Remove the cover (see "[Removing the Cover](#)" in "Troubleshooting Your System").
3. Rotate the system board tray levers up simultaneously until the tray releases from the chassis (see [Figure 6-6](#)).

**Figure 6-6. Removing and Installing the System Board Tray**

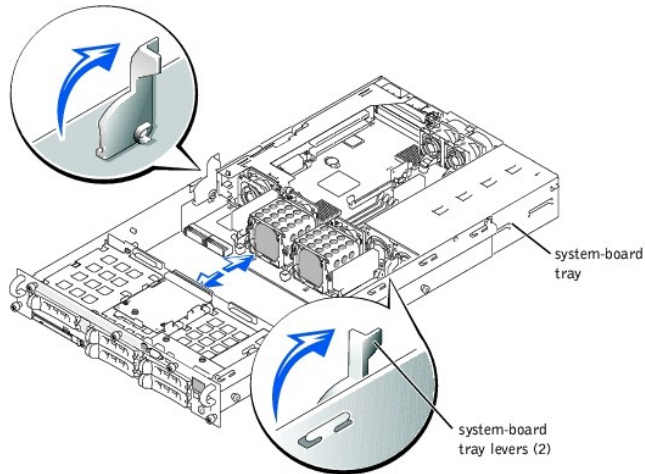

4. Pull the system board tray straight back until it stops.
5. Lift the front of the system board tray upward slightly and then pull the tray straight back until it clears the chassis.

## Replacing the System Board Tray

➔ **NOTICE:** See "Protecting Against Electrostatic Discharge" in the safety instructions in your *System Information* document.

1. With the system board tray levers in the upright position, slide the tray into the chassis until it stops (see [Figure 6-6](#)).
2. Rotate the system board tray levers down simultaneously until the tray is secured in the chassis (see [Figure 6-3](#)).
3. Replace the cover (see "[Replacing the Cover](#)" in "Troubleshooting Your System").

## Microprocessors

To take advantage of future options in speed and functionality, you can add a second microprocessor or replace either the primary or secondary microprocessor.

➔ **NOTICE:** The second microprocessor must be of the same type as the first. If the two microprocessors are different speeds, both will operate at the speed of the slower microprocessor.

Each microprocessor and its associated cache memory are contained in a PGA package that is installed in a ZIF socket on the system board. A second ZIF socket accommodates a secondary microprocessor.

🔍 **NOTE:** In a single microprocessor system, the microprocessor must be installed in the PROC 1 socket.

The following items are included in the microprocessor upgrade kit:

- 1 A microprocessor
- 1 A heat sink
- 1 Two securing clips
- 1 A cooling fan
- 1 A VRM, if adding a second microprocessor

## Adding or Replacing a Microprocessor

⚠ **CAUTION:** Before you perform this procedure, you must turn off the system and disconnect it from its power source. For more information, see "[Safety First—For You and Your System](#)" in "Troubleshooting Your System."

➔ **NOTICE:** See "Protecting Against Electrostatic Discharge" in the safety instructions in your *System Information* document.

1. Turn off the system, including any attached peripherals, and disconnect the system from the electrical outlet.
2. Remove the cover (see "[Removing the Cover](#)" in "Troubleshooting Your System").

If you are installing a second microprocessor, go to step 6.

🔍 **NOTE:** The system is designed to allow you to remove the microprocessor heat sink without removing the microprocessor cooling fan. However, you can remove the fan to provide easier access to the heat sink (see "[Removing a Cooling Fan](#)").

3. Remove the microprocessor heat sink:
  - a. Press down on the heat-sink securing clips to release the clips from the retaining tabs on the ZIF socket (see [Figure 6-7](#)).
  - b. Remove the heat sink securing clips.

**⚠ CAUTION:** The microprocessor and heat sink can become extremely hot. Be sure the microprocessor has had sufficient time to cool before handling.

**👉 NOTICE:** Never remove the heat sink from a microprocessor unless you intend to remove the microprocessor. The heat sink is required to maintain proper thermal conditions.

- c. Remove the heat sink.

**Figure 6-7. Removing and Installing the Heat Sink**

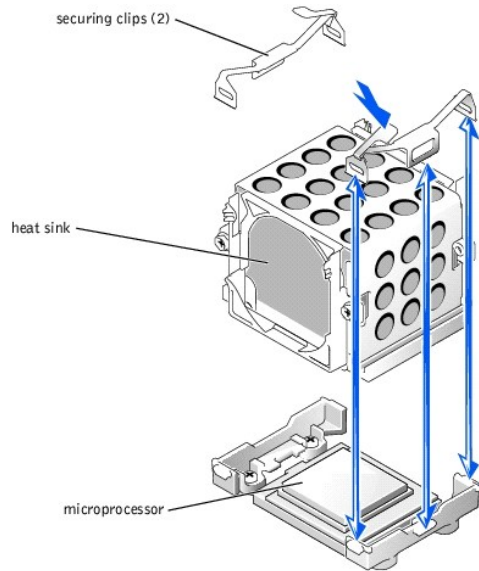

4. Pull the socket release lever straight up until the microprocessor is released (see [Figure 6-8](#)).
5. Lift the microprocessor out of the socket and leave the release lever up so that the socket is ready for the new microprocessor.

**👉 NOTICE:** Be careful not to bend any of the pins when removing the microprocessor. Bending the pins can permanently damage the microprocessor.

**Figure 6-8. Removing and Installing the Microprocessor**

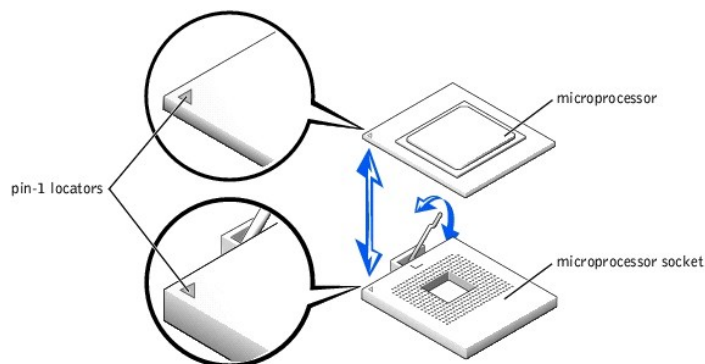

6. Unpack the new microprocessor.

If any of the pins on the microprocessor appear bent, see "[Getting Help](#)" for instructions on obtaining technical assistance.
7. Ensure that the release lever on the microprocessor socket is in the upright position.



- Align pin 1 on the microprocessor (see [Figure 6-8](#)) with pin 1 on the microprocessor socket.

 **NOTE:** No force is needed to install the microprocessor in the socket. When the microprocessor is aligned correctly, it should drop into the socket.

- Install the microprocessor in the socket (see [Figure 6-8](#)).

 **NOTICE:** Positioning the microprocessor incorrectly can permanently damage the microprocessor and the system when you turn on the system. When placing the microprocessor in the socket, be sure that all of the pins on the microprocessor go into the corresponding holes. Be careful not to bend the pins.

- When the microprocessor is fully seated in the socket, rotate the socket release lever back down until it snaps into place, securing the microprocessor.
- Place the new heat sink on top of the microprocessor (see [Figure 6-7](#)).
- Orient the securing clips as shown in [Figure 6-7](#).
- Hook the end of the clips without the latch to the tab on the edge of the socket.
- Push down and pivot the securing clip latch until the hole on the clip latches onto the ZIF socket tab.

 **NOTICE:** A cooling fan is required for each microprocessor to maintain proper thermal conditions.

- Ensure that the microprocessor cooling fan is installed:
  - If you removed the microprocessor cooling fan before you removed the microprocessor heat sink, replace the fan.
  - If you installed a second microprocessor, install the fan for the new microprocessor.

For information on installing or replacing a cooling fan, see "[Replacing a Cooling Fan](#)."

- If you are adding a second microprocessor, install the VRM in the VRM 2 connector, pushing down firmly to make sure that the latches engage (see [Figure 6-9](#)).

**Figure 6-9. Installing the VRM**

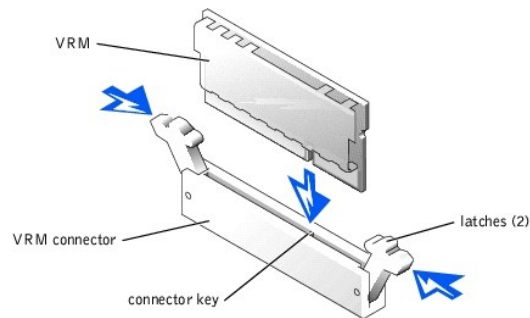

- Replace the cover (see "[Replacing the Cover](#)" in "Troubleshooting Your System").
- Reconnect the system to its electrical outlet and turn the system on, including any attached peripherals.
- Enter the System Setup program, and ensure that the microprocessor options match the new system configuration (see "Using the System Setup Program" in your *User's Guide*).

As the system boots, it detects the presence of the new microprocessor and automatically changes the system configuration information in the System Setup program. If you installed a second microprocessor, a message similar to the following appears:

```
Two 1.8 GHz Processors, Processor Bus: 400 MHz, L2 cache 512 KB Advanced
```

If only one microprocessor is installed, a message similar to the following appears:

```
One 1.8 GHz Processor, Processor Bus: 400 MHz, L2 cache 512 KB Advanced
```

- Confirm that the top line of the system data area in the System Setup program correctly identifies the installed microprocessor(s) (see "Using the System Setup Program" in your *User's Guide*).
- Exit the System Setup program.
- Run the system diagnostics to verify that the new microprocessor is operating correctly.



See "[Running System Diagnostics](#)" for information on running the diagnostics and troubleshooting any problems that may occur.

---

## System Battery

The system battery is a 3.0-volt (V), coin-cell battery.

## Replacing the System Battery

-  **CAUTION:** Before you perform this procedure, you must turn off the system and disconnect it from its power source. For more information, see "[Safety First—For You and Your System](#)" in "Troubleshooting Your System."
-  **CAUTION:** There is a danger of a new battery exploding if it is incorrectly installed. Replace the battery only with the same or equivalent type recommended by the manufacturer. Discard used batteries according to the manufacturer's instructions. See the *System Information* document for additional information.
-  **NOTICE:** See "Protecting Against Electrostatic Discharge" in the safety instructions in your *System Information* document.

1. Turn off the system, including any attached peripherals, and disconnect the system from the electrical outlet.
2. Remove the cover (see "[Removing the Cover](#)" in "Troubleshooting Your System").
3. Remove the expansion-card cage (see "[Removing the Expansion-Card Cage](#)").
4. Remove the system battery (see [Figure 6-10](#)).

See [Figure A-3](#) to locate the system battery on the system board.

You can pry the system battery out of its connector with your fingers or with a blunt, nonconductive object such as a plastic screwdriver.

5. Install the new system battery with the side labeled "+" facing up (see [Figure 6-10](#)).

**Figure 6-10. Removing and Installing the System Battery**

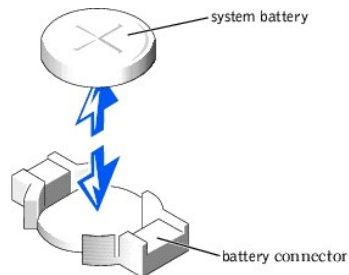

6. Replace the expansion-card cage (see "[Replacing the Expansion-Card Cage](#)").
7. Replace the cover (see "[Replacing the Cover](#)" in "Troubleshooting Your System").
8. Reconnect the system to its electrical outlet and turn the system on, including any attached peripherals.
9. Enter the System Setup program to confirm that the battery is operating properly (see "Using the System Setup Program," in the *User's Guide*).
10. Enter the correct time and date in the System Setup program's **Time** and **Date** fields.
11. Exit the System Setup program.
12. To test the newly installed battery, turn off the system and disconnect it from the electrical outlet for at least an hour.
13. After an hour, reconnect the system to its electrical outlet and turn it on.
14. Enter the System Setup program and if the time and date are still incorrect, see "[Getting Help](#)" for instructions on obtaining technical assistance.

[Back to Contents Page](#)

## Installing Drives

### Dell™ PowerEdge™ 2650 Systems Installation and Troubleshooting Guide

- [SCSI Interface Cables](#)
- [SCSI Configuration Information](#)
- [External SCSI Tape Drive](#)
- [SCSI Hard Drives](#)
- [CD and Diskettes Drives](#)
- [Activating the Integrated RAID Controller](#)
- [Installing a RAID Controller Card](#)
- [Installing a SCSI Backplane Daughter Card](#)
- [Configuring the Boot Device](#)

Your system contains up to five 1-inch SCSI hard drives. A CD drive and a diskette drive are mounted together on a tray that slides in the front panel and SCSI backplane board. This design allows the diskette and CD drives to be serviced without removing the cover or connecting and disconnecting cables. This section contains instructions for replacing these devices.

---

## SCSI Interface Cables

SCSI interface connectors are keyed for correct insertion. Keying ensures that the pin-1 wire in the cable connects to pin 1 in the connectors on both ends. When you disconnect an interface cable, take care to grasp the cable connector, rather than the cable itself, to avoid stress on the cable.

---

## SCSI Configuration Information

Although SCSI devices are installed in essentially the same way as other devices, their configuration requirements are different. To configure an external SCSI device, follow the guidelines in the following subsections.

### SCSI ID Numbers

Each device attached to a SCSI host adapter must have a unique SCSI ID number from 0 to 15.

A SCSI tape drive is configured by default as SCSI ID 6.

 **NOTE:** There is no requirement that SCSI ID numbers be assigned sequentially or that devices be attached to the cable in order by ID number.

### Device Termination

SCSI logic requires that termination be enabled for the two devices at opposite ends of the SCSI chain and disabled for all devices in between. For internal SCSI devices, termination is configured automatically. For external SCSI devices, you should disable termination on all devices and use terminated cables. See the documentation provided with any optional SCSI device you purchase for information on disabling termination.

---

## External SCSI Tape Drive

This subsection describes how to configure and install an external SCSI tape drive.

### Installing an External SCSI Tape Drive

 **NOTE:** See "Protecting Against Electrostatic Discharge" in the safety instructions in your *System Information* document.

1. Turn off the system, including any attached peripherals, and disconnect the system from the electrical outlet.
2. Prepare the tape drive for installation.

Ground yourself by touching an unpainted metal surface on the back of the system, unpack the drive (and controller card, if applicable), and compare the jumper and switch settings with those in the drive documentation.

See "[SCSI Configuration Information](#)," for information on setting the drive's SCSI ID number and enabling termination (if required). Change any settings necessary for your system's configuration.

3. Connect the tape drive's interface cable to the external SCSI connector on the controller card.
  4. Reconnect the system to its electrical outlet and turn the system on, including any attached peripherals.
  5. Perform a tape backup and verification test with the drive as instructed in the software documentation that came with the drive.
-

## SCSI Hard Drives

This subsection describes how to install and configure SCSI hard drives in the system's internal hard-drive bays.

### Before You Begin

Before attempting to remove or install a drive while the system is running, see the documentation for the RAID controller card ensure that the system is configured correctly to support hot-pluggable drive removal and insertion.

SCSI hard drives are supplied in special drive carriers that fit in the hard-drive bays.

 **NOTE:** You should only use drives that have been tested and approved for use with the SCSI backplane board.

You may need to use different programs than those provided with the operating system to partition and format SCSI hard drives. See "Installing and Configuring SCSI Drivers" in the *User's Guide* for information and instructions.

 **NOTICE:** Do not turn off or reboot your system while the drive is being formatted. Doing so can cause a drive failure.

When you format a high-capacity SCSI hard drive, allow enough time for the formatting to be completed. Long format times for these drives are normal. For example, an exceptionally large drive can take over an hour to format.

### SCSI Backplane Board Configuration

The hard-drive bays provide space for up to five 1-inch SCSI hard drives. The hard drives connect to a controller on the system board or a RAID controller card through the SCSI backplane board.

The system provides several options for hard drive configurations:

- 1 SCSI backplane daughter card (see "[Installing a SCSI Backplane Daughter Card](#)"):
  - o 1x5 configuration, without the SCSI backplane daughter card installed
  - o 2/3 split configuration, with the SCSI backplane daughter card installed
- 1 SCSI controller:
  - o Onboard SCSI controller
  - o Optional integrated RAID controller (see "[Activating the Integrated RAID Controller](#)")
  - o RAID controller card (see "[Installing a RAID Controller Card](#)")
- 1 Cabling:
  - o If a RAID controller card is not installed, no cables are required to use either the onboard SCSI controller or optional integrated RAID controller in either a 1x5 or 2/3 split configuration.
  - o If a RAID controller card is installed, cables can be connected from the controller card to SCSI A and/or SCSI B backplane board connector(s). A backplane board connector that is not attached to the RAID controller card will use the onboard SCSI controller or optional integrated RAID controller.
  - o If a cable is connected to the SCSI B backplane board connector, the SCSI backplane daughter card must be installed to activate the 2/3 split configuration. Otherwise, the system will display an error message.

See [Figure A-5](#) to locate the connectors on the SCSI backplane board.

### Installing a SCSI Hard Drive

 **NOTICE:** When installing a hard drive, ensure that the adjacent drives are fully installed. Inserting a hard-drive carrier and attempting to lock its handle next to a partially installed carrier can damage the partially installed carrier's shield spring and make it unusable.

 **NOTICE:** Not all operating systems support hot-plug drive installation. See the documentation supplied with your operating system.

1. Remove the bezel (see "[Removing the Bezel](#)" in "Troubleshooting Your System").
2. Open the hard-drive carrier handle (see [Figure 7-1](#)).

Figure 7-1. Installing a SCSI Hard-Drive

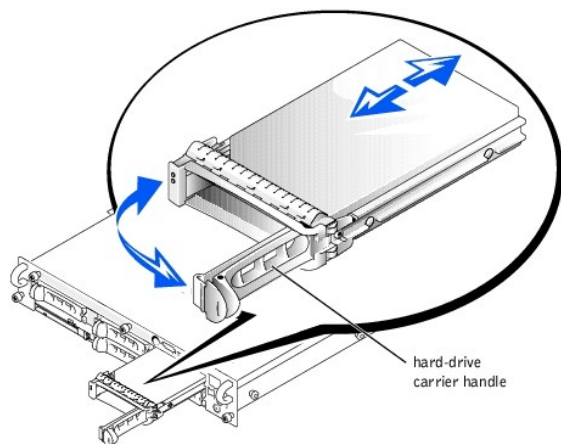

➔ **NOTICE:** Do not insert a hard-drive carrier and attempt to lock its handle next to a partially installed carrier. Doing so can damage the partially installed carrier's shield spring and make it unusable. Ensure that the adjacent drive carrier is fully installed.

3. Insert the hard-drive carrier into the drive bay (see [Figure 7-1](#)).
4. Close the hard-drive carrier handle to lock it in place.
5. Replace the bezel (see "[Replacing the Bezel](#)" in "Troubleshooting Your System").
6. Install any required SCSI device drivers (see "Installing and Configuring SCSI Drivers" in the *User's Guide* for information).
7. If the hard drive is new, run the SCSI controllers test in system diagnostics.

## Removing a SCSI Hard Drive

➔ **NOTICE:** Not all operating systems support hot-plug drive installation. See the documentation supplied with your operating system.

1. Remove the bezel (see "[Removing the Bezel](#)" in "Troubleshooting Your System").
2. Take the hard drive offline and wait until the SCSI hard-drive indicator codes on the drive carrier signal that the drive may be removed safely (see [Table 2-6](#)).

If the drive has been online, the drive status indicator will blink green two times a second as the drive is powered down. When all indicators are off, the drive is ready for removal.

See your operating system documentation for more information on taking the hard drive offline.

3. Open the hard-drive carrier handle to release the drive (see [Figure 7-1](#)).
4. Slide the hard drive out until it is free of the drive bay (see [Figure 7-1](#)).

If you are permanently removing the hard drive, install a blank insert.

5. Replace the bezel (see "[Replacing the Bezel](#)" in "Troubleshooting Your System").

## CD and Diskettes Drives

A CD drive and a diskette drive mount together on a tray that slides in the front panel and connects to the controllers on the system board through the SCSI backplane board.

### Removing the CD/Diskette Drive Tray

1. Turn off the system, including any attached peripherals, and disconnect the system from its electrical outlet.
2. Remove the bezel (see "[Removing the Bezel](#)" in "Troubleshooting Your System").
3. Grasp the CD/diskette drive tray release handle and pull the tray from the system (see [Figure 7-2](#)).
4. Slide the CD/diskette drive tray out of the system.

Figure 7-2. Removing and Installing the CD/Diskette Drive Tray

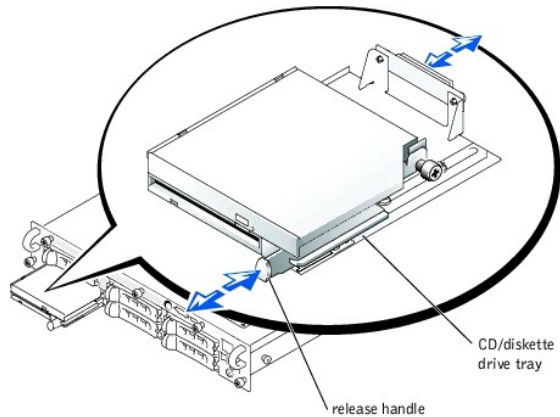

## Installing the CD/Diskette Drive Tray

1. Align the CD/diskette drive tray with the opening in the front panel.
2. Press the CD/diskette drive tray release handle until the tray snaps into place (see [Figure 7-2](#)).
3. Replace the bezel (see "[Replacing the Bezel](#)" in "Troubleshooting Your System").
4. Reconnect your system and peripherals to their electrical outlets, and turn on the system.

## Activating the Integrated RAID Controller

**⚠ CAUTION:** Replace the battery only with the same or equivalent type recommended by the manufacturer. Discard used batteries according to the manufacturer's instructions. See the *System Information* document for additional information.

**⚠ CAUTION:** Before you perform this procedure, you must turn off the system and disconnect it from its power source. For more information, see "[Safety First—For You and Your System](#)" in "Troubleshooting Your System."

**➡ NOTICE:** See "Protecting Against Electrostatic Discharge" in the safety instructions in your *System Information* document.

**➡ NOTICE:** To avoid possible data loss, back up all data on the hard drives before changing the mode of operation of the integrated SCSI controller from SCSI to RAID.

1. Turn off the system, including any attached peripherals, and disconnect the system from the electrical outlet.
2. Remove the cover (see "[Removing the Cover](#)" in "Troubleshooting Your System").
3. Push the ejectors on the RAID memory module connector down and outward to allow the memory module to be inserted into the connector (see [Figure 7-3](#)).

See [Figure A-3](#) to locate the RAID memory module connector on the system board.

4. Align the memory module's edge connector with the alignment keys, and insert the memory module in the connector (see [Figure 7-3](#)).

The memory module connector has two alignment keys that allow the memory module to be installed in the connector in only one way.

**🔍 NOTE:** The RAID controller memory module must be an unbuffered memory module, rated to run at 100 MHz or faster. Do not substitute registered memory modules such as those used for system memory.

5. Press on the memory module with your thumbs while pulling up on the ejectors with your index fingers to lock the memory module into the connector.

**Figure 7-3. Installing the RAID Controller Memory Module**

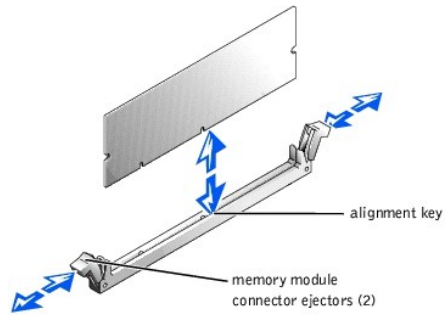

6. Push the ejectors on the RAID hardware key connector down and outward to allow the key to be inserted into the connector (see [Figure 7-4](#)).
  7. Insert the RAID hardware key into its connector on the system board and secure the key with the latches on each end of the connector (see [Figure 7-4](#)).
- See [Figure A-3](#) to locate the RAID hardware key on the system board.
8. Press on the hardware key with your thumbs while pulling up on the ejectors with your index fingers to lock the hardware key into the connector.

**Figure 7-4. Installing the RAID Hardware Key**

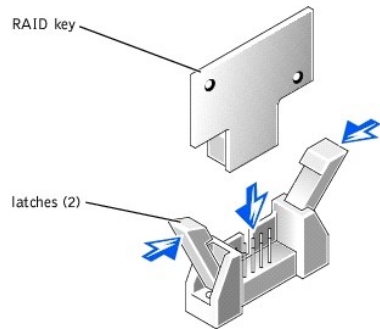

9. Connect the battery cable to the RAID battery cable connector on the system board.
- See [Figure A-3](#) to locate the RAID battery cable connector on the system board.
10. Hook the retention tab on the bottom of the battery into the slot in the chassis side wall, and then snap the battery release clip into place (see [Figure 7-5](#)).

**Figure 7-5. Removing and Installing the RAID Battery**

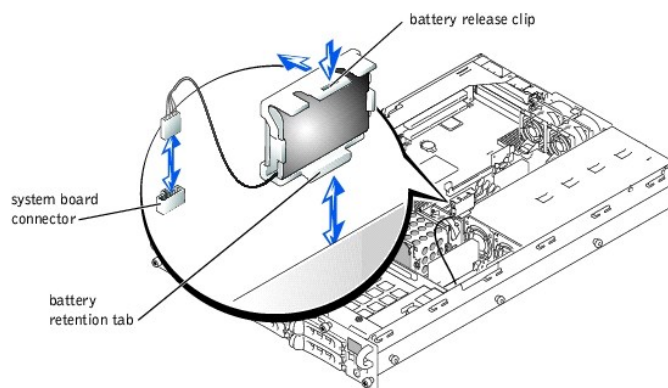

11. Replace the cover (see ["Replacing the Cover"](#) in "Troubleshooting Your System").
12. Reconnect the system to its electrical outlet and turn the system on, including any attached peripherals.
13. Enter the System Setup program and verify that the setting for the SCSI controller has changed to reflect the presence of the RAID hardware (see

"Using the System Setup Program" in your *User's Guide*).

14. Install the RAID software.

See the RAID controller documentation for more information.

---

## Installing a RAID Controller Card

Follow these general guidelines when installing a RAID controller card. For specific instructions, see the documentation supplied with the RAID controller card.

 **CAUTION:** Before you perform this procedure, you must turn off the system and disconnect it from its power source. For more information, see "[Safety First—For You and Your System](#)" in "Troubleshooting Your System."

 **NOTICE:** See "Protecting Against Electrostatic Discharge" in the safety instructions in your *System Information* document.

1. Unpack the RAID controller card, and prepare it for installation.

For instructions, see the documentation accompanying the card.

2. Turn off the system, including any attached peripherals, and disconnect the system from the electrical outlet.
3. Remove the cover (see "[Removing the Cover](#)" in "Troubleshooting Your System").
4. Install the RAID controller card (see "[Installing an Expansion Card](#)" in "Installing System Options").
5. Connect SCSI interface cables supplied with the card to the SCSI A and/or SCSI B connectors on the SCSI backplane board.

 **NOTE:** Cables can be connected from the RAID controller card to SCSI A and/or SCSI B backplane board connector(s). A backplane board connector that is not attached to the RAID controller card will use the onboard SCSI controller or optional integrated RAID controller.

To identify the connector on the RAID controller card, see documentation for the card. See [Figure A-5](#) to locate the SCSI controller connectors on the SCSI backplane board.

Route the SCSI cables over the SCSI backplane board to the expansion-card cage.

6. Connect the external SCSI devices to the card's external connector on the system's back panel.

If you are attaching multiple external SCSI devices, daisy-chain the devices to each other using the cables shipped with each device.

7. Replace the cover (see "[Replacing the Cover](#)" in "Troubleshooting Your System").
8. Reconnect the system to its electrical outlet and turn the system on, including any attached peripherals.
9. Install any required SCSI device drivers (see "Installing and Configuring SCSI Drivers" in the *User's Guide*).
10. Test the SCSI devices.

Test a SCSI hard drive by running the **SCSI Controllers** test in the system diagnostics.

---

## Installing a SCSI Backplane Daughter Card

To operate the SCSI backplane in a 2/3 split backplane configuration, you must install a daughter card.

 **CAUTION:** Before you perform this procedure, you must turn off the system and disconnect it from its power source. For more information, see "[Safety First—For You and Your System](#)" in "Troubleshooting Your System."

 **NOTICE:** See "Protecting Against Electrostatic Discharge" in the safety instructions in your *System Information* document.

1. Unpack the SCSI backplane board daughter card kit.
2. Turn off the system, including any attached peripherals, and disconnect the system from the electrical outlet.
3. Remove the cover (see "[Removing the Cover](#)" in "Troubleshooting Your System").
4. The daughter card fits between the sides of the card guide above the drive bay. To install the daughter card in the card guide, performing the following steps:
  - a. Hold the daughter card by its edges with the component side facing up and the card connector facing the SCSI backplane board (see [Figure 7-6](#)).
  - b. Ensure that the retention lever is in the open position.
  - c. Position the card in the drive bay so that the notches on the left and right edges of the card are aligned with the tabs on the card guide above the drive bay.
  - d. Lower the card into the card guide.
  - e. Close the retention lever to slide the daughter card into the SCSI backplane connector and lock the card into place (see [Figure 7-6](#)).

**Figure 7-6. Installing a SCSI Backplane Daughter Card**



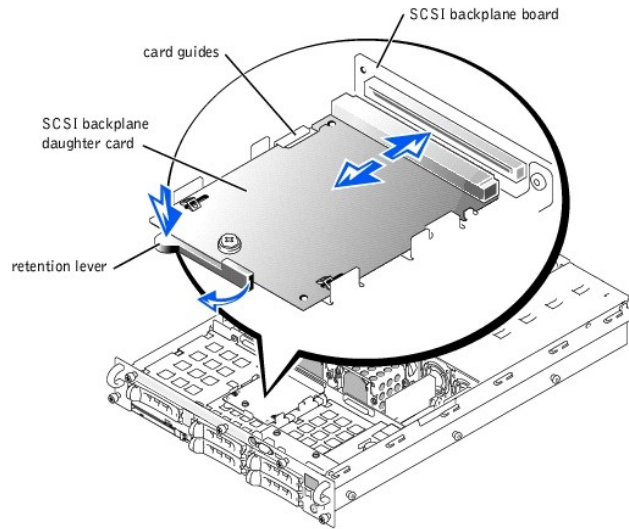

5. Reconfigure the SCSI cable connections to the SCSI backplane as necessary to operate the backplane as a 2/3 split backplane:
    1. If a RAID controller card is not installed, no cables are required to use either the onboard SCSI controller or optional integrated RAID controller in either a 1x5 or 2/3 split configuration.
    1. If a RAID controller card is installed, cables can be connected from the controller card to SCSI A and/or SCSI B backplane board connector(s). A backplane board connector that is not attached to the RAID controller card will use the onboard SCSI controller or optional integrated RAID controller.
    1. If a cable is connected to the SCSI B backplane board connector, the SCSI backplane daughter card must be installed to activate the 2/3 split configuration. Otherwise, the system will display an error message.
- See [Figure A-5](#) to locate the connectors on the SCSI backplane board.
6. Replace the cover (see "[Replacing the Cover](#)" in "Troubleshooting Your System").
  7. Reconnect your system and peripherals to their electrical outlets, and turn on the system.

---

## Configuring the Boot Device

If you plan to boot the system from a hard drive, the drive must be attached to the primary (or boot) controller. The device that the system boots from is determined by the boot order specified in the System Setup program.

The System Setup program provides options that the system uses to scan for installed boot devices. See your system's *User's Guide* for information about the System Setup program.

---

[Back to Contents Page](#)

[Back to Contents Page](#)

## Getting Help

### Dell™ PowerEdge™ 2650 Systems Installation and Troubleshooting Guide

- [Help Overview](#)
  - [Dell Contact Numbers](#)
- 

## Help Overview

This section describes the tools Dell provides to help you when you have a problem with your computer. It also tells you when and how to contact Dell for technical or customer assistance.

### Technical Assistance

If you need assistance with a technical problem, perform the following steps:

1. Complete the procedures in "[Troubleshooting Your System](#)."
2. Run the system diagnostics.
3. Make a copy of the Diagnostics Checklist, and fill it out.
4. Use Dell's extensive suite of online services available at the Dell | Support website ([support.dell.com](http://support.dell.com)) for help with installation and troubleshooting procedures.

For more information, see "[World Wide Web](#)."

5. If the preceding steps have not resolved the problem, call Dell for technical assistance.

When prompted by Dell's automated telephone system, enter your Express Service Code to route the call directly to the proper support personnel. If you do not have an Express Service Code, open the **Dell Accessories** folder, double-click the **Express Service Code** icon, and follow the directions.

 **NOTE:** Dell's Express Service Code system may not be available in all countries.

For instructions on using the technical support service, see "[Technical Support Service](#)" and "[Before You Call](#)."

## Help Tools

Dell provides a number of tools to assist you. These tools are described in the following sections.

 **NOTE:** Some of the following tools are not always available in all locations outside the continental U.S. Please call your local Dell representative for information on availability.

### World Wide Web

The Internet is your most powerful tool for obtaining information about your computer and other Dell products. Through the Internet, you can access most of the services described in this section, including AutoTech, TechFax, order status, technical support, and product information.

You can access Dell | Support at [support.dell.com](http://support.dell.com). Select your region on the **WELCOME TO DELL SUPPORT** page, and fill in the requested details to access help tools and information.

Dell can be accessed electronically using the following addresses:

- 1 World Wide Web

[www.dell.com/](http://www.dell.com/)

[www.dell.com/ap/](http://www.dell.com/ap/) (for Asian/Pacific countries only)

[www.euro.dell.com](http://www.euro.dell.com) (for Europe only)

[www.dell.com/la/](http://www.dell.com/la/) (for Latin American countries)

- 1 Anonymous file transfer protocol (FTP)

[ftp.dell.com/](ftp://ftp.dell.com/)

Log in as user:anonymous, and use your e-mail address as your password.

- 1 Electronic Support Service

[support@us.dell.com](mailto:support@us.dell.com)

[apsupport@dell.com](mailto:apsupport@dell.com) (for Asian/Pacific countries only)

[support.euro.dell.com](mailto:support.euro.dell.com) (for Europe only)

- 1 Electronic Quote Service

sales@dell.com

apmarketing@dell.com (for Asian/Pacific countries only)

- 1 Electronic Information Service

info@dell.com

## AutoTech Service

Dell's automated technical support service—AutoTech—provides recorded answers to the questions most frequently asked by Dell customers about their portable and desktop computer systems.

When you call AutoTech, you use your touch-tone telephone to select the subjects that correspond to your questions.

The AutoTech service is available 24 hours a day, seven days a week. You can also access this service through the technical support service. For the telephone number to call, see "[Dell Contact Numbers](#)."

## TechFax Service

Dell takes full advantage of fax technology to serve you better. Twenty-four hours a day, seven days a week, you can call the Dell TechFax line toll-free for all kinds of technical information.

Using a touch-tone phone, you can select from a full directory of topics. The technical information you request is sent within minutes to the fax number you designate. For the TechFax telephone number to call, see "[Dell Contact Numbers](#)."

## Automated Order-Status System

You can call this automated service to check on the status of any Dell products that you have ordered. A recording prompts you for the information needed to locate and report on your order. For the telephone number to call, see "[Dell Contact Numbers](#)."

## Technical Support Service

Dell's industry-leading hardware technical-support service is available 24 hours a day, seven days a week, to answer your questions about Dell hardware. Our technical support staff use computer-based diagnostics to provide fast, accurate answers to questions.

To contact Dell's technical support service, see "[Before You Call](#)" and then call the number for your country as listed in "[Dell Contact Numbers](#)."

## Problems With Your Order

If you have a problem with your order, such as missing parts, wrong parts, or incorrect billing, contact Dell for customer assistance. Have your invoice or packing slip handy when you call. For the telephone number to call, see "[Dell Contact Numbers](#)."

## Product Information

If you need information about additional products available from Dell, or if you would like to place an order, visit the Dell website at [www.dell.com/](http://www.dell.com/). For the telephone number to call to speak to a sales specialist, see "[Dell Contact Numbers](#)."

## Returning Items for Warranty Repair or Credit

Prepare all items being returned, whether for repair or credit, as follows:

1. Call Dell to obtain an authorization number, and write it clearly and prominently on the outside of the box.  
For the telephone number to call, see "[Dell Contact Numbers](#)."
2. Include a copy of the invoice and a letter describing the reason for the return.
3. Include a copy of the [Diagnostics Checklist](#) indicating the tests you have run and any error messages reported by the system diagnostics.
4. Include any accessories that belong with the item(s) being returned (such as power cables, software floppy disks, and guides) if the return is for credit.
5. Pack the equipment to be returned in the original (or equivalent) packing materials.

You are responsible for paying shipping expenses. You are also responsible for insuring any product returned, and you assume the risk of loss during shipment to Dell. Collect-on-delivery (C.O.D.) packages are not accepted.

Returns that are missing any of the preceding requirements will be refused at our receiving dock and returned to you.

## Before You Call



**NOTE:** Have your Express Service Code ready when you call. The code helps Dell's automated-support telephone system direct your call more efficiently.

Remember to fill out the [Diagnostics Checklist](#). If possible, turn on your system before you call Dell for technical assistance and call from a telephone at or near the computer. You may be asked to type some commands at the keyboard, relay detailed information during operations, or try other troubleshooting steps possible only at the computer system itself. Make sure that the system documentation is available.



**CAUTION:** Before servicing any components inside your computer, see "[Safety First—For You and Your System](#)."

Diagnostics Checklist	
Name: _____	Date: _____
Address: _____	Phone number: _____
Service tag (bar code on the back of the computer): _____	
Express Service Code: _____	
Return Material Authorization Number (if provided by Dell support technician): _____	
Operating system and version: _____	
Peripherals: _____	
_____	
_____	
Expansion cards: _____	
_____	
_____	
Are you connected to a network?    yes <input type="checkbox"/> no <input type="checkbox"/>	
Network, version, and network card: _____	
Programs and versions: _____	
_____	
_____	
See your operating system documentation to determine the contents of the system's startup files. Print each file if possible. Otherwise, record the contents of each file before calling Dell.	
Error message, beep code, or diagnostic code: _____	
Description of problem and troubleshooting procedures you performed: _____	
_____	
_____	
_____	

## Dell Contact Numbers

The following table provides country-specific access codes and telephone numbers, websites, and email addresses that you can use to contact Dell.

The codes required depend on where you are calling from as well as the destination of your call; in addition, each country has a different dialing protocol. If you need assistance in determining which codes to use, contact a local or an international operator.

 **NOTE:** Toll-free numbers are for use only within the country for which they are listed. Area codes are most often used to call long distance within your own country (not internationally)—in other words, when your call originates in the same country you are calling.

Country (City) International Access Code Country Code City Code	Department Name or Service Area, Website and E-Mail Address	Area Codes, Local Numbers, and Toll Free Numbers
<b>Antigua and Barbuda</b>	General Support	1-800-805-5924
<b>Argentina (Buenos Aires)</b>  International Access Code: 00  Country Code: 54  City Code: 11	Tech Support and Customer Care	toll free: 1-800-444-0733
	Sales	toll free: 1-800-444-3355
	Tech Support Fax	11 4515 7139
	Customer Care Fax	11 4515 7138
	Website: <a href="http://www.dell.com.ar">www.dell.com.ar</a>	
<b>Australia (Sydney)</b>  International Access Code: <b>0011</b>  Country Code: <b>61</b>  City Code: <b>2</b>	Home and Small Business	1-300-65-55-33
	Government and Business	toll free: 1-800-633-559
	Preferred Accounts Division (PAD)	toll free: 1-800-060-889
	Customer Care	toll free: 1-800-819-339
	Corporate Sales	toll free: 1-800-808-385
	Transaction Sales	toll free: 1-800-808-312
	Fax	toll free: 1-800-818-341
<b>Austria (Vienna)</b>  International Access Code:	Home/Small Business Sales	01 795 67602
	Home/Small Business Fax	01 795 67605

<b>900</b>	Home/Small Business Customer Care	01 795 67603
Country Code: <b>43</b>	Preferred Accounts/Corporate Customer Care	0660 8056
City Code: <b>1</b>	Home/Small Business Technical Support	01 795 67604
	Preferred Accounts/Corporate Technical Support	0660 8779
	Switchboard	01 491 04 0
	Website: <a href="http://support.euro.dell.com">support.euro.dell.com</a>	
	E-mail: <a href="mailto:tech_support_central_europe@dell.com">tech_support_central_europe@dell.com</a>	
<b>Barbados</b>	General Support	1-800-534-3066
<b>Belgium (Brussels)</b> International Access Code: <b>00</b> Country Code: <b>32</b> City Code: <b>2</b>	Technical Support	02 481 92 88
	Customer Care	02 481 91 19
	Home/Small Business Sales	toll free: 0800 16884
	Corporate Sales	02 481 91 00
	Fax	02 481 92 99
	Switchboard	02 481 91 00
	Website: <a href="http://support.euro.dell.com">support.euro.dell.com</a>	
	E-mail: <a href="mailto:tech_be@dell.com">tech_be@dell.com</a>	
	E-mail for French Speaking Customers: <a href="mailto:support.euro.dell.com/be/fr/emaildell/">support.euro.dell.com/be/fr/emaildell/</a>	
<b>Bermuda</b>	General Support	1-800-342-0671
<b>Brazil</b> International Access Code: <b>0021</b> Country Code: <b>55</b> City Code: <b>51</b>	Customer Support, Technical Support	0800 90 3355
	Tech Support Fax	51 481 5470
	Customer Care Fax	51 481 5480
	Sales	0800 90 3390
	Website: <a href="http://www.dell.com/br">www.dell.com/br</a>	
<b>Brunei</b> Country Code: <b>673</b>	Customer Technical Support (Penang, Malaysia)	604 633 4966
	Customer Service (Penang, Malaysia)	604 633 4949
	Transaction Sales (Penang, Malaysia)	604 633 4955
<b>Canada (North York, Ontario)</b> International Access Code: <b>011</b>	Automated Order-Status System	toll free: 1-800-433-9014
	AutoTech (Automated technical support)	toll free: 1-800-247-9362
	Customer Care (From outside Toronto)	toll free: 1-800-387-5759
	Customer Care (From within Toronto)	416 758-2400
	Customer Technical Support	toll free: 1-800-847-4096
	Sales (Direct sales—from outside Toronto)	toll free: 1-800-387-5752
	Sales (Direct sales—from within Toronto)	416 758-2200
	Sales (Federal government, education, and medical)	toll free: 1-800-567-7542
	Sales (Major accounts)	toll free: 1-800-387-5755
TechFax	toll free: 1-800-950-1329	
<b>Cayman Islands</b>	General Support	1-800-805-7541
<b>Chile (Santiago)</b> Country Code: <b>56</b> City Code: <b>2</b>	Sales, Customer Support, and Technical Support	toll free: 1230-020-4823
<b>China (Xiamen)</b> Country Code: <b>86</b> City Code: <b>592</b>	Home and Small Business Technical Support	toll free: 800 858 2437
	Corporate Accounts Technical Support	toll free: 800 858 2333
	Customer Experience	toll free: 800 858 2060
	Home and Small Business	toll free: 800 858 2222
	Preferred Accounts Division	toll free: 800 858 2062
	Large Corporate Accounts North	toll free: 800 858 2999
	Large Corporate Accounts East	toll free: 800 858 2020
	Large Corporate Accounts South	toll free: 800 858 2355
	Large Corporate Accounts GCP	toll free: 800 858 2055
	Large Corporate Accounts HK	toll free: 800 964108
	Large Corporate Accounts GCP HK	toll free: 800 907308
<b>Colombia</b>	General Support	980-9-15-3978
<b>Costa Rica</b>	General Support	0800-012-0435
<b>Czech Republic (Prague)</b> International Access Code: <b>00</b> Country Code: <b>420</b>	Technical Support	02 22 83 27 27
	Customer Care	02 22 83 27 11
	Fax	02 22 83 27 14
	TechFax	02 22 83 27 28

City Code: 2	Switchboard	02 22 83 27 11
	Website: <a href="http://support.euro.dell.com">support.euro.dell.com</a>	
	E-mail: <a href="mailto:czech_dell@dell.com">czech_dell@dell.com</a>	
<b>Denmark (Horsholm)</b> International Access Code: 00 Country Code: 45	Technical Support	45170182
	Relational Customer Care	45170184
	Home/Small Business Customer Care	32875505
	Switchboard	45170100
	Fax Technical Support (Upplands Vasby, Sweden)	46 0 859005594
	Fax Switchboard	45170117
	Website: <a href="http://support.euro.dell.com">support.euro.dell.com</a>	
	E-mail: <a href="mailto:den_support@dell.com">den_support@dell.com</a> E-mail Support for Servers: <a href="mailto:Nordic_server_support@dell.com">Nordic_server_support@dell.com</a>	
<b>Dominican Republic</b>	General Support	1-800-148-0530
<b>El Salvador</b>	General Support	01-899-753-0777
<b>Finland (Helsinki)</b> International Access Code: 990 Country Code: 358 City Code: 9	Technical Support	09 253 313 60
	Technical Support Fax	09 253 313 81
	Relational Customer Care	09 253 313 38
	Home/Small Business Customer Care	09 693 791 94
	Fax	09 253 313 99
	Switchboard	09 253 313 00
	Website: <a href="http://support.euro.dell.com">support.euro.dell.com</a>	
	E-mail: <a href="mailto:fin_support@dell.com">fin_support@dell.com</a>	
<b>France (Paris) (Montpellier)</b> International Access Code: 00 Country Code: 33 City Codes: (1) (4)	<b>Home and Small Business</b>	
	Technical Support	0825 387 270
	Customer Care	0825 823 833
	Switchboard	0825 004 700
	Switchboard (Alternative)	04 99 75 40 00
	Sales	0825 004 700
	Fax	0825 004 701
	Fax (Alternative)	04 99 75 40 01
	Website: <a href="http://support.euro.dell.com">support.euro.dell.com</a>	
	E-mail: <a href="mailto:support.euro.dell.com/fr/fr/emaildell/">support.euro.dell.com/fr/fr/emaildell/</a>	
	<b>Corporate</b>	
	Technical Support	0825 004 719
	Customer Care	0825 338 339
	Switchboard	01 55 94 71 00
	Sales	01 55 94 71 00
	Fax	01 55 94 71 01
	Website: <a href="http://support.euro.dell.com">support.euro.dell.com</a>	
	E-mail: <a href="mailto:support.euro.dell.com/fr/fr/emaildell/">support.euro.dell.com/fr/fr/emaildell/</a>	
<b>Germany (Langen)</b> International Access Code: 00 Country Code: 49 City Code: 6103	Technical Support	06103 766-7200
	Home/Small Business Customer Care	0180-5-224400
	Global Segment Customer Care	06103 766-9570
	Preferred Accounts Customer Care	06103 766-9420
	Large Accounts Customer Care	06103 766-9560
	Public Accounts Customer Care	06103 766-9555
	Switchboard	06103 766-7000
	Website: <a href="http://support.euro.dell.com">support.euro.dell.com</a> E-mail: <a href="mailto:tech_support_central_europe@dell.com">tech_support_central_europe@dell.com</a>	
<b>Guatemala</b>	General Support	1-800-999-0136
<b>Hong Kong</b> International Access Code: 001 Country Code: 852	Technical Support	toll free: 800 96 4107
	Customer Service (Penang, Malaysia)	604 633 4949
	Transaction Sales	toll free: 800 96 4109
	Corporate Sales	toll free: 800 96 4108
<b>India</b>	Technical Support	1600 33 8045
	Sales	1600 33 8044
<b>Ireland (Cherrywood)</b> International Access Code: 16	Technical Support	1850 543 543
	Home User Customer Care	01 204 4095

Country Code: <b>353</b> City Code: <b>1</b>	Small Business Customer Care	01 204 4026
	Corporate Customer Care	01 279 5011
	Sales	01 204 4444
	SalesFax	01 204 0144
	Fax	204 5960
	Switchboard	01 204 4444
	Website: <a href="http://support.euro.dell.com">support.euro.dell.com</a>	
	E-mail: <a href="mailto:dell_direct_support@dell.com">dell_direct_support@dell.com</a>	
<b>Italy (Milan)</b> International Access Code: <b>00</b> Country Code: <b>39</b> City Code: <b>02</b>	<b>Home and Small Business</b>	
	Technical Support	02 577 826 90
	Customer Care	02 696 821 14
	Fax	02 696 821 13
	Switchboard	02 696 821 12
	Website: <a href="http://support.euro.dell.com">support.euro.dell.com</a>	
	E-mail: <a href="mailto:support.euro.dell.com/it/it/emaildell/">support.euro.dell.com/it/it/emaildell/</a>	
	<b>Corporate</b>	
	Technical Support	02 577 826 90
	Customer Care	02 577 825 55
	Fax	02 575 035 30
	Switchboard	02 577 821
	Website: <a href="http://support.euro.dell.com">support.euro.dell.com</a>	
	E-mail: <a href="mailto:support.euro.dell.com/it/it/emaildell/">support.euro.dell.com/it/it/emaildell/</a>	
<b>Jamaica</b>	General Support	1-800-682-3639
<b>Japan (Kawasaki)</b> International Access Code: <b>001</b> Country Code: <b>81</b> City Code: <b>44</b>	Technical Support (Server)	toll free: 0120-1984-35
	Technical Support Outside of Japan (Server)	81-44-556-4152
	Technical Support (Dimension™ and Inspiron™)	toll free: 0120-1982-26
	Technical Support Outside of Japan (Dimension and Inspiron)	81-44-520-1435
	Technical Support (Dell Precision™, OptiPlex™, and Latitude™)	toll free: 0120-1984-33
	Technical Support Outside of Japan (Dell Precision, OptiPlex, and Latitude)	81-44-556-3894
	24-Hour Automated Order Service	044 556-3801
	Customer Care	044 556-4240
	Business Sales Division (Up to 400 employees)	044 556 3494
	Preferred Accounts Division Sales (Over 400 employees)	044 556-3433
	Large Corporate Accounts Sales (Over 3500 employees)	044 556-3440
	Public Sales (Government agencies, educational institutions, and medical institutions)	044 556 3440
	Global Segment Japan	044 556 3469
	Individual User	044 556 1657
	Faxbox Service	044 556-3490
	Switchboard	044 556-4300
Website: <a href="http://support.jp.dell.com">support.jp.dell.com</a>		
<b>Korea (Seoul)</b> International Access Code: <b>001</b> Country Code: <b>82</b> City Code: <b>2</b>	Technical Support	toll free: 080-200-3800
	Sales	toll free: 080-200-3600
	Customer Service (Seoul, Korea)	toll free: 080-200-3800
	Customer Service (Penang, Malaysia)	604 633 4949
	Fax	2194-6202
	Switchboard	2194-6000
<b>Latin America</b>	Customer Technical Support (Austin, Texas, U.S.A.)	512 728-4093
	Customer Service (Austin, Texas, U.S.A.)	512 728-3619
	Fax (Technical Support and Customer Service)(Austin, Texas, U.S.A.)	512 728-3883
	Sales (Austin, Texas, U.S.A.)	512 728-4397
	SalesFax (Austin, Texas, U.S.A.)	512 728-4600
		or 512 728-3772
<b>Luxembourg</b> International Access Code: <b>00</b> Country Code: <b>352</b>	Technical Support (Brussels, Belgium)	02 481 92 88
	Home/Small Business Sales (Brussels, Belgium)	toll free: 080016884
	Corporate Sales (Brussels, Belgium)	02 481 91 00
	Customer Care (Brussels, Belgium)	02 481 91 19
	Fax (Brussels, Belgium)	02 481 92 99
	Switchboard (Brussels, Belgium)	02 481 91 00

	Website: <a href="http://support.euro.dell.com">support.euro.dell.com</a>	
	E-mail: <a href="mailto:tech_be@dell.com">tech_be@dell.com</a>	
<b>Macau</b>	Technical Support	toll free: 0800 582
Country Code: <b>853</b>	Customer Service (Penang, Malaysia)	604 633 4949
	Transaction Sales	toll free: 0800 581
<b>Malaysia (Penang)</b>	Technical Support	toll free: 1 800 888 298
International Access Code: <b>00</b>	Customer Service	04 633 4949
Country Code: <b>60</b>	Transaction Sales	toll free: 1 800 888 202
City Code: <b>4</b>	Corporate Sales	toll free: 1 800 888 213
<b>Mexico</b>	Customer Technical Support	001-877-384-8979
International Access Code: <b>00</b>		or 001-877-269-3383
Country Code: <b>52</b>	Sales	50-81-8800
		or 01-800-888-3355
	Customer Service	001-877-384-8979
		or 001-877-269-3383
	Main	50-81-8800
		or 01-800-888-3355
<b>Netherlands Antilles</b>	General Support	001-800-882-1519
<b>Netherlands (Amsterdam)</b>	Technical Support	020 581 8838
International Access Code: <b>00</b>	Customer Care	020 581 8740
Country Code: <b>31</b>	Home/Small Business Sales	toll free: 0800-0663
City Code: <b>20</b>	Home/Small Business Sales Fax	020 682 7171
	Corporate Sales	020 581 8818
	Corporate Sales Fax	020 686 8003
	Fax	020 686 8003
	Switchboard	020 581 8818
	Website: <a href="http://support.euro.dell.com">support.euro.dell.com</a>	
	E-mail: <a href="mailto:tech_nl@dell.com">tech_nl@dell.com</a>	
<b>New Zealand</b>	Home and Small Business	0800 446 255
International Access Code: <b>00</b>	Government and Business	0800 444 617
Country Code: <b>64</b>	Sales	0800 441 567
	Fax	0800 441 566
<b>Nicaragua</b>	General Support	001-800-220-1006
<b>Norway (Lysaker)</b>	Technical Support	671 16882
International Access Code: <b>00</b>	Relational Customer Care	671 17514
Country Code: <b>47</b>	Home/Small Business Customer Care	23162298
	Switchboard	671 16800
	Fax Technical Support (Upplands Vasby, Sweden)	46 0 85 590 05 594
	Fax Switchboard	671 16865
	Website: <a href="http://support.euro.dell.com">support.euro.dell.com</a>	
	E-mail: <a href="mailto:nor_support@dell.com">nor_support@dell.com</a>	
	E-mail Support for Servers: <a href="mailto:Nordic_server_support@dell.com">Nordic_server_support@dell.com</a>	
<b>Panama</b>	General Support	001-800-507-0962
<b>Peru</b>	General Support	0800-50-669
<b>Poland (Warsaw)</b>	Customer Service Phone	57 95 700
International Access Code: <b>011</b>	Customer Care	57 95 999
Country Code: <b>48</b>	Sales	57 95 999
City Code: <b>22</b>	Customer Service Fax	57 95 806
	Reception Desk Fax	57 95 998
	Switchboard	57 95 999
	Website: <a href="http://support.euro.dell.com">support.euro.dell.com</a>	
	E-mail: <a href="mailto:pl_support@dell.com">pl_support@dell.com</a>	
<b>Portugal</b>	Technical Support	35 800 834 077
International Access Code: <b>00</b>	Customer Care	800 300 415 or 35 800 834 075
Country Code: <b>35</b>	Sales	800 300 410 or 800 300 411 or 800 300 412 or



		351 214 220 710
	Fax	35 121 424 01 12
	E-mail: support.euro.dell.com/es/es/emaildell/	
<b>Puerto Rico</b>	General Support	1-800-805-7545
<b>St. Lucia</b>	General Support	1-800-882-1521
<b>Singapore (Singapore)</b>	Technical Support	toll free: 800 6011 051
International Access Code: 005	Customer Service (Penang, Malaysia)	604 633 4949
	Transaction Sales	toll free: 800 6011 054
Country Code: 65	Corporate Sales	toll free: 800 6011 053
<b>South Africa (Johannesburg)</b>	Technical Support	011 709 7710
International Access Code: 09/091	Customer Care	011 709 7707
	Sales	011 709 7700
Country Code: 27	Fax	011 706 0495
	Switchboard	011 709 7700
City Code: 11	Website: support.euro.dell.com	
	E-mail: dell_za_support@dell.com	
<b>Southeast Asian and Pacific Countries</b>	Customer Technical Support, Customer Service, and Sales (Penang, Malaysia)	604 633 4810
<b>Spain (Madrid)</b>	<b>Home and Small Business</b>	
International Access Code: 00	Technical Support	902 100 130
	Customer Care	902 118 540
Country Code: 34	Sales	902 118 541
	Switchboard	902 118 541
City Code: 91	Fax	902 118 539
	Website: support.euro.dell.com	
	E-mail: support.euro.dell.com/es/es/emaildell/	
	<b>Corporate</b>	
	Technical Support	902 100 130
	Customer Care	902 118 546
	Switchboard	91 722 92 00
	Fax	91 722 95 83
	Website: support.euro.dell.com	
	E-mail: support.euro.dell.com/es/es/emaildell/	
<b>Sweden (Upplands Vasby)</b>	Technical Support	08 590 05 199
International Access Code: 00	Relational Customer Care	08 590 05 642
	Home/Small Business Customer Care	08 587 70 527
Country Code: 46	Fax Technical Support	08 590 05 594
	Sales	08 590 05 185
City Code: 8	Website: support.euro.dell.com	
	E-mail: swe_support@dell.com	
	E-mail Support for Latitude and Inspiron: Swe-nbk_kats@dell.com	
	E-mail Support for OptiPlex: Swe_kats@dell.com	
	E-mail Support for Servers: Nordic_server_support@dell.com	
<b>Switzerland (Geneva)</b>	Technical Support (Home and Small Business)	0844 811 411
International Access Code: 00	Technical Support (Corporate)	0844 822 844
	Customer Care (Home and Small Business)	0848 802 202
Country Code: 41	Customer Care (Corporate)	0848 821 721
	Fax	022 799 01 90
City Code: 22	Switchboard	022 799 01 01
	Website: support.euro.dell.com	
	E-mail: swisstech@dell.com	
	E-mail for French Speaking HSB and Corporate Customers: support.euro.dell.com/ch/fr/emaildell/	
<b>Taiwan</b>	Technical Support	toll free: 0080 60 1255
International Access Code: 002	Technical Support (Servers)	toll free: 0080 60 1256
	Transaction Sales	toll free: 0080 651 228
Country Code: 886		or 0800 33 556
	Corporate Sales	toll free: 0080 651 227

		or 0800 33 555
<b>Thailand</b> International Access Code: <b>001</b> Country Code: <b>66</b>	Technical Support	toll free: 0880 060 07
	Customer Service (Penang, Malaysia)	604 633 4949
	Sales	toll free: 0880 060 09
<b>Trinidad/Tobago</b>	General Support	1-800-805-8035
<b>U.K. (Bracknell)</b> International Access Code: <b>00</b> Country Code: <b>44</b> City Code: <b>1344</b>	Technical Support (Corporate/Preferred Accounts/PAD [1000+ employees])	0870 908 0500
	Technical Support (Direct/PAD and general)	0870 908 0800
	Global Accounts Customer Care	01344 723186
	Home and Small Business Customer Care	0870 906 0010
	Corporate Customer Care	01344 72 3185
	Preferred Accounts (500-5000 employees) Customer Care	01344 723196
	Central Government Customer Care	01344 723193
	Local Government Customer Care	01344 723194
	Home/Small Business Sales	0870 907 4000
	Corporate/Public Sector Sales	01344 860456
	Website: <a href="http://support.euro.dell.com">support.euro.dell.com</a>	
	E-mail: <a href="mailto:dell_direct_support@dell.com">dell_direct_support@dell.com</a>	
<b>U.S.A. (Austin, Texas)</b> International Access Code: <b>011</b> Country Code: <b>1</b>	Automated Order-Status System	toll free: 1-800-433-9014
	AutoTech (For portable and desktop computers)	toll free: 1-800-247-9362
	<b>Dell Home and Small Business Group</b> (For portable and desktop computers):	
	Customer Technical Support (Return material authorization numbers)	toll free: 1-800-624-9896
	Customer Technical Support (Home sales purchased via <a href="http://www.dell.com">www.dell.com</a> )	toll free: 1-877-576-3355
	Customer Service (Credit return authorization numbers)	toll free: 1-800-624-9897
	<b>National Accounts</b> (Computers purchased by established Dell national accounts [have your account number handy], medical institutions, or value-added resellers [VARs]):	
	Customer Service and Technical Support (Return material authorization numbers)	toll free: 1-800-822-8965
	<b>Public Americas International</b> (Computers purchased by governmental agencies [local, state, or federal] or educational institutions):	
	Customer Service and Technical Support (Return material authorization numbers)	toll free: 1-800-234-1490
	Dell Sales	toll free: 1-800-289-3355 or toll free: 1-800-879-3355
	Spare Parts Sales	toll free: 1-800-357-3355
	Desktop and Portable Fee-Based Technical Support	toll free: 1-800-433-9005
	Sales (Catalogs)	toll free: 1-800-426-5150
	Fax	toll free: 1-800-727-8320
	TechFax	toll free: 1-800-950-1329
	Dell Services for the Deaf, Hard-of-Hearing, or Speech-Impaired	toll free: 1-877-DELLTTY (1-877-335-5889)
	Switchboard	512 338-4400
	DellNet™ Technical Support	toll free: 1-877-Dellnet (1-877-335-5638)
	<b>US Virgin Islands</b>	General Support
<b>Venezuela</b>	General Support	8001-3605

[Back to Contents Page](#)